



I/O Modulo de salida

Manual de usuario

User Manual

COPYRIGHT ©2018 Hangzhou Hikvision Digital Technology Co., Ltd.

ALL RIGHTS RESERVED.

Any and all information, including, among others, wordings, pictures, graphs are the properties of Hangzhou Hikvision Digital Technology Co., Ltd. or its subsidiaries (hereinafter referred to be “Hikvision”). This user manual (hereinafter referred to be “the Manual”) cannot be reproduced, changed, translated, or distributed, partially or wholly, by any means, without the prior written permission of Hikvision. Unless otherwise stipulated, Hikvision does not make any warranties, guarantees or representations, express or implied, regarding to the Manual.

About this Manual

This Manual is applicable to I/O Output Module.

The manual includes instructions for using and managing the product. Pictures, charts, images and all other information hereinafter are for description and explanation only. The information contained in the Manual is subject to change, without notice, due to firmware updates or other reasons. Please find the latest version in the company website (<http://overseas.hikvision.com/en/>).

Please use this user manual under the guidance of professionals.

Trademarks Acknowledgement

HIKVISION and other Hikvision’s trademarks and logos are the properties of Hikvision in various jurisdictions. Other trademarks and logos mentioned below are the properties of their respective owners.

Legal Disclaimer

TO THE MAXIMUM EXTENT PERMITTED BY APPLICABLE LAW, THE PRODUCT DESCRIBED, WITH ITS HARDWARE, SOFTWARE AND FIRMWARE, IS PROVIDED “AS IS”, WITH ALL FAULTS AND ERRORS, AND HIKVISION MAKES NO WARRANTIES, EXPRESS OR IMPLIED, INCLUDING WITHOUT LIMITATION, MERCHANTABILITY, SATISFACTORY QUALITY, FITNESS FOR A PARTICULAR PURPOSE, AND NON-INFRINGEMENT OF THIRD PARTY. IN NO EVENT WILL HIKVISION, ITS DIRECTORS, OFFICERS, EMPLOYEES, OR AGENTS BE LIABLE TO YOU FOR ANY SPECIAL, CONSEQUENTIAL, INCIDENTAL, OR INDIRECT DAMAGES, INCLUDING, AMONG OTHERS, DAMAGES FOR LOSS OF BUSINESS PROFITS, BUSINESS INTERRUPTION, OR LOSS OF DATA OR DOCUMENTATION, IN CONNECTION WITH THE USE OF THIS PRODUCT, EVEN IF HIKVISION HAS BEEN ADVISED OF THE POSSIBILITY OF SUCH DAMAGES. REGARDING TO THE PRODUCT WITH INTERNET ACCESS, THE USE OF PRODUCT SHALL BE WHOLLY AT YOUR OWN RISKS. HIKVISION SHALL NOT TAKE ANY RESPONSIBILITIES FOR ABNORMAL OPERATION, PRIVACY LEAKAGE OR OTHER DAMAGES RESULTING FROM CYBER ATTACK, HACKER ATTACK, VIRUS INSPECTION, OR OTHER INTERNET

SECURITY RISKS; HOWEVER, HIKVISION WILL PROVIDE TIMELY TECHNICAL SUPPORT IF REQUIRED.

SURVEILLANCE LAWS VARY BY JURISDICTION. PLEASE CHECK ALL RELEVANT LAWS IN YOUR JURISDICTION BEFORE USING THIS PRODUCT IN ORDER TO ENSURE THAT YOUR USE CONFORMS THE APPLICABLE LAW. HIKVISION SHALL NOT BE LIABLE IN THE EVENT THAT THIS PRODUCT IS USED WITH ILLEGITIMATE PURPOSES.

IN THE EVENT OF ANY CONFLICTS BETWEEN THIS MANUAL AND THE APPLICABLE LAW, THE LATER PREVAILS.

Regulatory Information

FCC Information

FCC compliance: This equipment has been tested and found to comply with the limits for a digital device, pursuant to part 15 of the FCC Rules. These limits are designed to provide reasonable protection against harmful interference when the equipment is operated in a commercial environment. This equipment generates, uses, and can radiate radio frequency energy and, if not installed and used in accordance with the instruction manual, may cause harmful interference to radio communications. Operation of this equipment in a residential area is likely to cause harmful interference in which case the user will be required to correct the interference at his own expense.

FCC Conditions

This device complies with part 15 of the FCC Rules. Operation is subject to the following two conditions:

1. This device may not cause harmful interference.
2. This device must accept any interference received, including interference that may cause undesired operation.

EU Conformity Statement



This product and - if applicable - the supplied accessories too are marked with "CE" and comply therefore with the applicable harmonized European standards listed under the EMC Directive 2004/108/EC, the RoHS Directive 2011/65/EU.



2012/19/EU (WEEE directive): Products marked with this symbol cannot be disposed of as unsorted municipal waste in the European Union. For proper recycling, return this product to your local supplier upon the purchase of equivalent new equipment, or dispose of it at designated collection points. For more information, see: www.recyclethis.info.



2006/66/EC (battery directive): This product contains a battery that cannot be disposed of as unsorted municipal waste in the European Union. See the product documentation for specific battery information. The battery is marked with this symbol, which may include lettering to indicate cadmium (Cd), lead (Pb), or mercury (Hg).

For proper recycling, return the battery to your supplier or to a designated collection point. For more information see: www.recyclethis.info.

Industry Canada ICES-003 Compliance

This device meets the CAN ICES-3 (A)/NMB-3(A) standards requirements.

Preventive and Cautionary Tips

Before connecting and operating your device, please be advised of the following tips:

- Ensure unit is installed in a well-ventilated, dust-free environment.
- Keep all liquids away from the device.

- Ensure environmental conditions meet factory specifications.
- Ensure unit is properly secured to a rack or shelf. Major shocks or jolts to the unit as a result of dropping it may cause damage to the sensitive electronics within the unit.
- Use the device in conjunction with an UPS if possible.
- Power down the unit before connecting and disconnecting accessories and peripherals.
- A factory recommended HDD should be used for this device.
- Improper use or replacement of the battery may result in hazard of explosion. Replace with the same or equivalent type only. Dispose of used batteries according to the instructions provided by the manufacturer.

Preventive and Cautionary Tips

To guarantee the card reader works properly, please read and obey the notes below.

- If the card reader is powered by the controller, the power supply distance is recommended to be no longer than 100m. If the distance is longer than 100m, you are advised to power the card reader by external 12V (range: -%10 ~ +%10) DC power supply, which is nonswitched and linear.
- To guarantee the communication between the controller and the card reader, you must use RVVP cable above 0.5 to connect them.
- If the card reader is installed outside or in environment easy to permeable, it is advisable to install a waterproof shield.
- If you need to install several card readers, the distance among them must over 30cm.
- To reduce the noise in long distance transmission, the shield of cable should connect to the GND of both controller and card reader terminal.

Content

Chapter 1	Overview	1
Chapter 2	Appearance	2
2.1	Front View	2
2.2	Rear View (Dial-up)	2
2.3	Indicators Information	3
Chapter 3	Terminals	5
Chapter 4	Wiring	6
Chapter 5	DIP Switch Introduction	7

Chapter 1 Overview

The I/O output module can switch the signal transferred via RS-485 to I/O output signal. The DS-K5603-Z face recognition terminal can access to the third-party swing barrier with the help of the I/O output module.

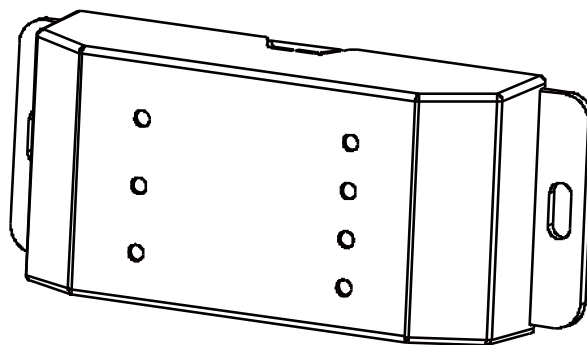

Figure 1. 1 I/O Output Module

Chapter 2 Appearance

2.1 Front View

The front view of the I/O output module is shown as below:

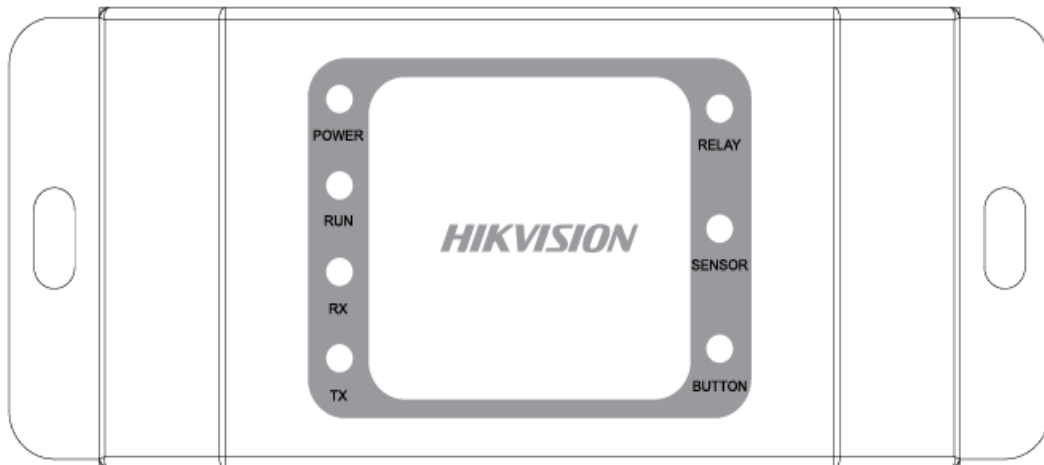

Figure 2. 1 Front View of I/O Output Module

2.2 Rear View (Dial-up)

The rear view of the I/O output module is shown as below:

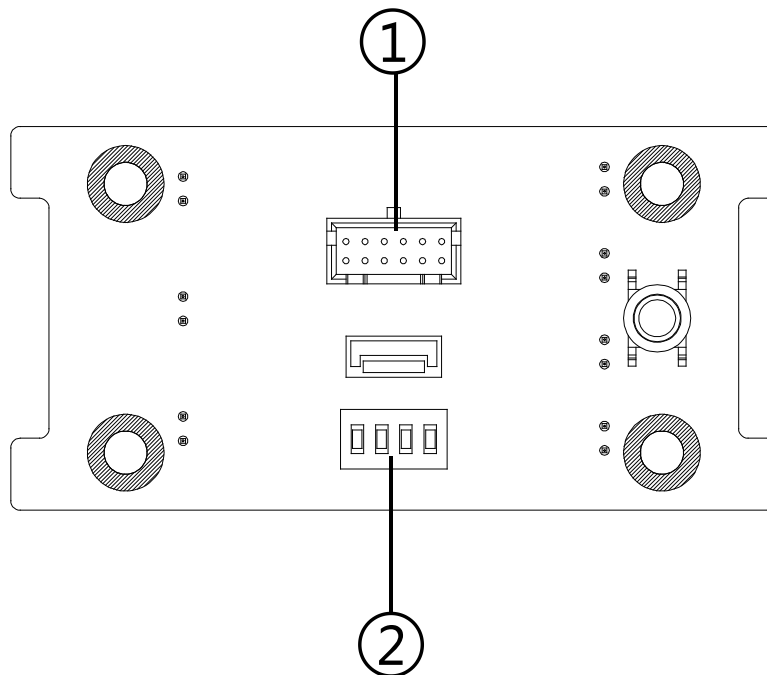

Figure 2. 2 Rear View of I/O Output Module

Table 2. 1 Description of Rear View

No.	Description
1	Cable Interface
2	DIP Switch (Set Door Open Duration) Note: For details, see <i>Chapter 5 DIP Switch Introduction</i> .

Note: Other components are only supported in the secure door control unit mode. If you want to change the device to secure door control unit, please contact our technical support. The I/O output module mode and the secure door control unit mode cannot be supported at the same time.

2.3 Indicators Information

DS-K2M060 I/O output module has 4 indicators: RX, TX, RELAY and POWER

Note: Other indicators are only supported in the secure door control unit mode. If you want to change the device to secure door control unit, please contact our technical support. The I/O output module mode and the secure door control unit mode cannot be supported at the same time.

The following tables introduce the meaning of different indicator's status:

POWER:

Solid Red	The unit is powered on.
-----------	-------------------------

RUN:

Flashing Green	The tempering prevention switch is open. Tempering alarm.
Solid Green	The tempering prevention switch is open. The device is running.

RX, TX - RS 485 Communication Indicator:

Flashing Green	The RS 485 communication is connected.
Solid Green	The RS 485 communication is disconnected.

RELAY: Indicate the lock status:

Green	<p>The indicator will be solid green for a while when the opening door action is done. (The opening door action includes swiping the card, remote opening door and so on.)</p> <p>Note:</p> <ul style="list-style-type: none"> ● The unit should be powered on. ● The unit is connecting the lock.
-------	---

SENSOR – Indicate the door magnetic status:

Green	<p>The indicator is solid green when the door is open. When the door is closed, the indicator is off.</p> <p>Note:</p> <ul style="list-style-type: none"> ● The unit should be powered on. ● The unit is connecting the door magnetic.
-------	---

BUTTON – Indicate the Door button

Green	<p>The green light is on when press the Door button. When release the button, the green light will be off.</p> <p>Note:</p> <ul style="list-style-type: none">● The unit should be powered on.● The unit is connecting the Door button.
-------	---

Chapter 3 Terminals

The figure displayed below is the terminals of the device. You can connect the RS-485 terminal to the face recognition terminal and the third party swing barrier.

Note: Other terminals except for the RS-485 terminal are only supported to wire in the secure door control unit mode. If you want to change the device to secure door control unit, please contact our technical support. The I/O output module mode and the secure door control unit mode cannot be supported at the same time.

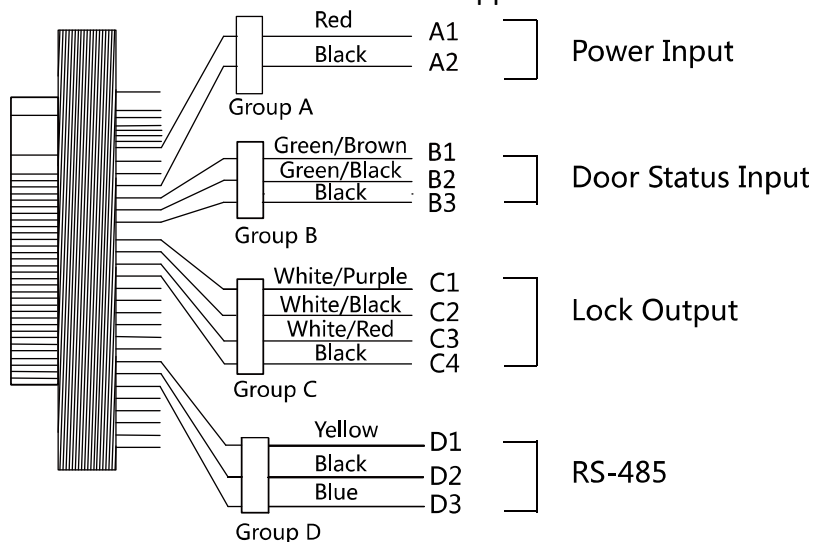

Figure 3. 1 Terminals Diagram

The table displayed below shows the terminals descriptions:

Table 3. 1 Terminals Descriptions

Group	Cable No.	Color	Name	Descriptions
A	A1	Red	+12V	Power Input
	A2	Black	GND	
B	B1	Green/Brown	SENSOR_IN	Door Status Input
	B2	Green/Black	BUTTON_IN	
	B3	Black	GND	
C	C1	White/Purple	DOOR_NC	Lock Output
	C2	White/Black	DOOR_COM	
	C3	White/Red	DOOR_NO	
	C4	Black	GND	
D	D1	Yellow	485 +	RS-485
	D2	Black	GND	
	D3	Blue	485 -	

Chapter 4 Wiring

You can follow the diagram below to wire the DS-K5603-Z face recognition terminal and the third party swing barrier.

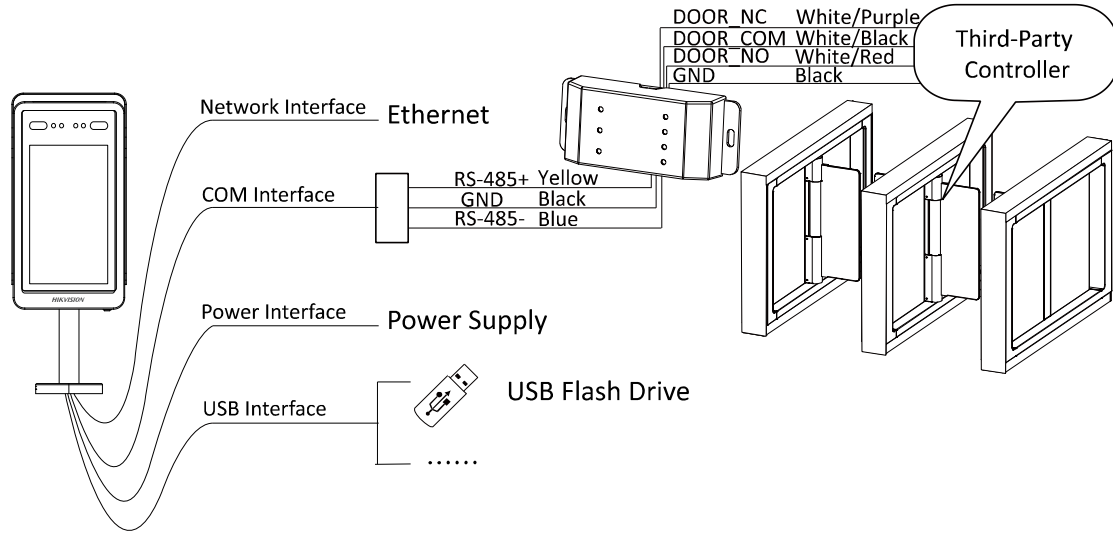

Chapter 5 DIP Switch Introduction

Purpose:

You can set the swing barrier's door open duration by setting the DIP switch. The DIP switch module is shown below. The number from left to right is No. 1 to No. 4, which is from low bit to high bit.

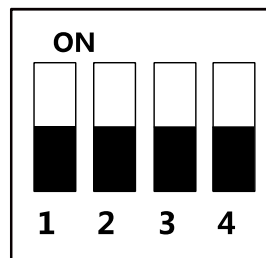



Figure 5. 1 DIP Switch Module (Binary Code: 0000)

The table shows below is the description of the DIP switch.

Table 5. 1 Description of DIP Switch

Icon	Description
	Binary value is 1
	Binary value is 0

For example, the binary value of the following figure is 1100.

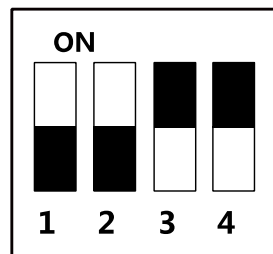

Figure 5. 2 DIP Switch Module (Binary Code: 1100)

You can set the DIP switch to control the swing barrier's door open duration. The DIP switch binary value and its corresponded door open duration is as follows:

Decimal Value	Binary Value	Door Open Duration
0	0000	1 s
1	0001	2 s
2	0010	3 s
3	0011	4 s
4	0100	5 s

Decimal Value	Binary Value	Door Open Duration
5	0101	6 s
6	0110	7 s
7	0111	8 s
8	1000	9 s
9	1001	10 s
10	1010	11 s
11	1011	12 s
12	1100	13 s
13	1101	14 s
14	1110	15 s
15	1111	16 s

Note: After changing the DIP switch value, you should reboot the module to apply the settings.



✉ ventas@rosarioseguridad.com.ar 📷 [rosarioseguridadok](https://www.instagram.com/rosarioseguridadok)
📞 +54 9 341 6708000 📺 [Rosario Seguridad](https://www.youtube.com/channel/UC...)
📞 +54 9 341 6799822 📺 [Rosario Seguridad](https://www.facebook.com/RosarioSeguridad)

Grupo Instaladores

📺 <https://www.facebook.com/groups/591852618012744/>
📞 +54 9 341 6591429
📞 +54 9 341 4577532

Avenida Presidente Perón 3998 - Rosario - Santa Fe - Argentina