

DS-2TD2138-15/QY
Camara Termica Bullet IP Anti-Corrosion



La cámara de red tipo bala térmica anticorrosión DS-2TD2138-15/QY de Hikvision se aplica con fines de protección perimetral y prevención de incendios en infraestructuras críticas como aeropuertos, ferrocarriles, prisiones, centrales eléctricas, tiendas, etc. Con el sensor de plano focal no refrigerado de óxido de vanadio, mejora la calidad de la imagen térmica. Tiene un revestimiento anticorrosión para cumplir con los requisitos de uso en un entorno anticorrosión.

Funciones Clave

- Resolución de 384 × 288, 12 μm, VOx UFPA, NETD < 35 mK (25 °C, F1.0)
- Alarma de excepción de temperatura para prevención de incendios, -20 °C a 150 °C (-4 °F a 302 °F), ± 8 °C (± 14,4 °F)
- Tecnología de procesamiento de imágenes: lineal, histograma, modo AGC térmico autoadaptativo, DDE, 3D DNR
- Función de protección perimetral, basada en algoritmo inteligente: cruce de línea, intrusión, entrada y salida de región
- Detector de alta calidad con 10 años de garantía

▪ Especificaciones

Modulo Termal	
Image Sensor	Vanadium Oxide Uncooled Focal Plane Arrays
Resolution	384 × 288
Pixel Pitch	12 μm
Spectral Range	8 μm to 14 μm
NETD	< 35 mK (25°C, F1.0)
Focal Length	15 mm
IFOV	0.80 mrad
Field of View	17.0° × 13.0° (H × V)
Min. Focusing Distance	2.5m
Aperture	F1.0
Digital Zoom	2×, 4×, 8×
Efectos de imagenes	
Target Coloration	Yes. Supported in white hot and black hot mode.
Funciones Inteligentes	
VCA	4 VCA rule types (line crossing, intrusion, region entrance, and region exiting), up to 8 VCA rules in total
Temperature Measurement	3 temperature measurement rule types, 21 rules in total (10 points, 10 areas, and 1 line)
Temperature Range	-20°C to 150°C (-4°F to 302°F)
Temperature Accuracy	± 8°C (± 14.4°F)
Video and Audio	
Main Stream	25 fps (1280 × 720, 704 × 576, 640 × 512, 352 × 288)
Sub-stream	25 fps (704 × 576, 640 × 512, 352 × 288)
Third Stream	25 fps (1280 × 720, 704 × 576, 640 × 512, 352 × 288)
Video Compression	Main Stream: H.265/H.264 Sub-Stream: H.265/H.264/MJPEG Third Stream: H.265/H.264/MJPEG
Audio Compression	G.722.1/G.711ulaw/G.711alaw/MP2L2/G.726/PCM
Red	
Protocols	IPv4/IPv6, HTTP, HTTPS, 802.1x, QoS, FTP, SMTP, UPnP, SNMP, DNS, DDNS, NTP, RTSP, RTCP, RTP, TCP, UDP, IGMP, ICMP, DHCP, PPPoE, SRTP, SFTP, SSL
API	ISAPI, HIKVISION SDK, and third-party management platform, Open Network Video Interface (Profile S, Profile G)
Security	User authentication (ID and password), MAC address binding, HTTPS encryption, IEEE 802.1x (EAP-MD5, EAP-TLS), access control, IP address filtering
Simultaneous Live View	Up to 20 channels
Client	iVMS-4200, Hik-Connect
Web Browser	Live view (plug-in allowed): Internet Explorer 11 Live view (plug-in free): Chrome 57.0 +, Firefox 52.0 + Local service: Chrome 57.0 +, Firefox 52.0 +
Network Storage	MicroSD/SDHC/SDXC card (up to 256 GB) local storage, and NAS (NFS, SMB/CIFS), auto network replenishment (ANR)
User/Host level	Up to 32 users, 3 levels: Administrator, Operator, User

Interface	
Analog Output	1.0 V [p-p]/75 Ω, PAL/NTSC/BNC
Alarm Input	2, alarm input (0 to 5 VDC)
Alarm Output	2, alarm output (alarm response actions configurable)
Alarm Action	SD recording/Relay output/Smart capture/FTP upload/Email linkage
Audio Input	1, 3.5 mm Mic in/Line in interface Line input: 2 to 2.4 V [p-p], output impedance: 1 KΩ ± 10%
Audio Output	Linear level, impedance: 600 Ω
Communication Interface	1, RJ45 10 M/100 M self-adaptive Ethernet interface 1, RS-485 interface (half duplex)
General	
Web Client Language	32 languages English, Russian, Estonian, Bulgarian, Hungarian, Greek, German, Italian, Czech, Slovak, French, Polish, Dutch, Portuguese, Spanish, Romanian, Danish, Swedish, Norwegian, Finnish, Croatian, Slovenian, Serbian, Turkish, Korean, Traditional Chinese, Thai, Vietnamese, Japanese, Latvian, Lithuanian, Portuguese (Brazil)
Power Supply	24 VAC ± 25%, 12 VDC ± 25%, two-core terminal block PoE (802.3af, class 3)
Power Consumption	24 VAC ± 25%: 0.13 A to 0.22 A, Max. 5 W 12 VDC ± 25%: 0.37 A to 0.61 A, Max. 5 W PoE (802.3af, class 3): 44 V to 57 V: 0.1 A to 0.13 A, Max. 5.5 W
Working Temperature/Humidity	Temperature: -40 °C to 65 °C (-40 °F to 149 °F) Humidity: 90% or less
Protection Level	IP67 Standard TVS 6000V lightning protection, surge protection, voltage transient protection, IK10-rated housing
Dimensions	351.3 mm × 113.5 mm × 115.2 mm (13.83" × 4.47" × 4.53")
Weight	Approx. 1.77 kg (3.90 lb)

DRI Range Table

*La tabla es solo para referencia y el rendimiento puede variar según el entorno.

*Las distancias óptimas de detección, reconocimiento e identificación se calculan según los criterios de Johnson.

Rango de detección: para distinguir un objeto del fondo, el objeto debe estar cubierto por 1,5 o más píxeles.

Rango de reconocimiento: Para clasificar el objeto (animal, humano, vehículo, etc.), el objeto debe estar cubierto por 6 o más píxeles.

Rango de identificación: para identificar el objeto y describirlo en detalle, el objeto debe estar cubierto por 12 o más píxeles.

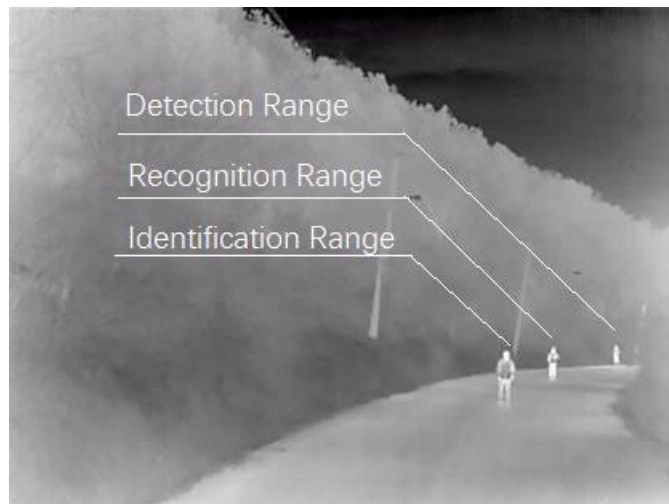

Detection Range (Vehicles: 1.4 × 4.0 m)	Detection Range (Humans: 1.8 × 0.5 m)	Recognition Range (Vehicles: 1.4 × 4.0 m)	Recognition Range (Humans: 1.8 × 0.5 m)	Identification Range (Vehicles: 1.4 × 4.0 m)	Identification Range (Humans: 1.8 × 0.5 m)
1917 m	625 m	479 m	156 m	240 m	78 m

Tabla Funciones Inteligentes

* The table is only for reference and the performance may vary according to different environment.

VCA Range (Vehicles: 1.4 × 4.0 m)	VCA Range (Humans: 1.8 × 0.5 m)	Temperature Measurement (Object: 1 × 1 m)	Temperature Measurement (Object: 0.2 × 0.2 m)	Fire Detection (Object: 0.2 × 0.2 m)
450 m	150 m	250 m	50 m	180 m

▪ Modelo disponible

DS-2TD2138-15/QY

▪ **Dimensiones**

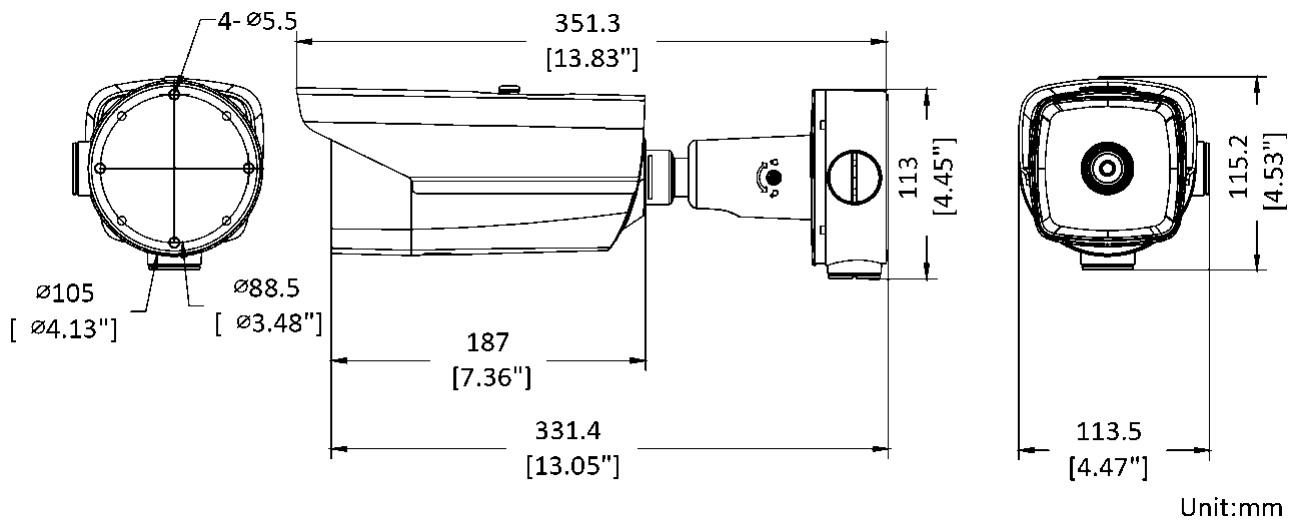

▪ **Accesorios**

▪ **Incluido**



DS-1260ZJ-AC#SA
Junction box

▪ **Opcional**







DS-1276ZJ-SUS
Corner Mount





DS-1275ZJ-S-SUS
Vertical Pole Mount

AVISO DE CUMPLIMIENTO: Los productos de la serie térmica pueden estar sujetos a controles de exportación en varios países o regiones, incluidos, entre otros, los Estados Unidos, la Unión Europea, el Reino Unido y/u otros países miembros del Acuerdo Wassenaar. Consulte a su experto legal o de cumplimiento profesional o a las autoridades del gobierno local para conocer los requisitos de licencia de exportación necesarios si tiene la intención de transferir, exportar o reexportar los productos de la serie térmica entre diferentes países..

Distributed by

✉ ventas@rosarioseguridad.com.ar  [rosarioseguridadok](https://www.instagram.com/rosarioseguridadok)
 +54 9 341 6708000  [Rosario Seguridad](https://www.youtube.com/RosarioSeguridad)
 +54 9 341 6799822  [Rosario Seguridad](https://www.facebook.com/RosarioSeguridad)

Grupo Instaladores

 <https://www.facebook.com/groups/591852618012744/>
 +54 9 341 6591429
 +54 9 341 4577532

Avenida Presidente Perón 3998 - Rosario - Santa Fe - Argentina**HIKVISION®****Headquarters**

No.555 Qianmo Road, Binjiang District,
 Hangzhou 310051, China
 T +86-571-8807-5998
overseasbusiness@hikvision.com

Hikvision USA
 T +1-909-895-0400
sales.usa@hikvision.com

Hikvision Australia
 T +61-2-8599-4233
salesau@hikvision.com

Hikvision India
 T +91-22-28469900
sales@pramahikvision.com

Hikvision Canada
 T +1-866-200-6690
sales.canada@hikvision.com

Hikvision Thailand
 T +662-275-9949
sales.thailand@hikvision.com

Hikvision Europe
 T +31-23-5542770
sales.eu@hikvision.com

Hikvision Italy
 T +39-0438-6902
info.it@hikvision.com

Hikvision Brazil
 T +55 11 3318-0050
Latam.support@hikvision.com

Hikvision Turkey
 T +90 (216)521 7070- 7074
sales.tr@hikvision.com

Hikvision Malaysia
 T +601-7652-2413
sales.my@hikvision.com

Hikvision UK & Ireland
 T +01628-902140
sales.uk@hikvision.com

Hikvision South Africa
 Tel: +27 (10) 0351172
sale.africa@hikvision.com

Hikvision France
 T +33(0)1-85-330-450
info.fr@hikvision.com

Hikvision Kazakhstan
 T +7-727-9730667
nikia.panfilov@hikvision.ru

Hikvision Vietnam
 T +84-974270888
sales.vt@hikvision.com

Hikvision UAE
 T +971-4-4432090
salesme@hikvision.com

Hikvision Singapore
 T +65-6684-4718
sg@hikvision.com

Hikvision Spain
 T +34-91-737-16-55
info.es@hikvision.com

Hikvision Tashkent
 T +99-87-1238-9438
uzb@hikvision.ru

Hikvision Hong Kong
 T +852-2151-1761
info.hk@hikvision.com

Hikvision Russia
 T +7-495-669-67-99
saleru@hikvision.com

Hikvision Korea
 T +82-(0)31-731-8817
sales.korea@hikvision.com

Hikvision Poland
 T +48-22-460-01-50
info.pl@hikvision.com

Hikvision Indonesia
 T +62-21-2933759
Sales.Indonesia@hikvision.com

Hikvision Colombia
sales.colombia@hikvision.com