

## DS-2CD3651G0-IZS

### Cámara de red tipo bala varifocal de 5 MP



- Imágenes de alta calidad con resolución de 5 MP
- Tecnología de compresión H.265+ eficiente para ahorrar ancho de banda y almacenamiento
- Imágenes claras contra una fuerte luz de fondo gracias a la tecnología WDR
- La tecnología 3D DNR ofrece imágenes limpias y nítidas
- Fácil instalación con tecnología Power over Ethernet (PoE)
- Resistente al agua y al polvo (IP67)

## ▪ Especificaciones

<b>Camera</b>	
Image Sensor	1/2.7" Progressive Scan CMOS
Max. Resolución	2560 × 1920
Min. Iluminación	Color: 0.005 Lux @ (F1.6, AGC ON), B/W: 0 Lux with IR
Tiempo de obturación	1/3 s to 1/100,000 s
Ajuste de ángulo	Pan: 0° to 360°, tilt: 0° to 100°, rotate: 0° to 360°
<b>Lens</b>	
Tipo Lente	Lente varifocal, lente motorizada, de 2,7 a 13,5 mm
Focal Length & FOV	2.7 to 13.5 mm: horizontal FOV 97° to 30°, vertical FOV 70° to 22°, diagonal FOV 128° to 37°
Montura Lente	Ø14
Iris Type	Fixed
Apertura	F1.6
<b>DORI</b>	
DORI	Varifocal lens: Wide: D: 64 m, O: 25 m, R: 13 m, I: 6 m Tele: D: 198 m, O: 79 m, R: 40 m, I: 20 m
<b>Iluminador</b>	
Gama de luces suplementarias	Hasta 60 m
Luz suplementaria inteligente	Yes
IR Longitud de onda	850 nm
<b>Video</b>	
Main Stream	50 Hz: 20 fps (2560 × 1920), 25 fps (2560 × 1440, 1920 × 1080, 1280 × 720) 60 Hz: 20 fps (2560 × 1920), 30 fps (2560 × 1440, 1920 × 1080, 1280 × 720)
Sub-Stream	50 Hz: 25 fps (1280 × 720, 640 × 480, 640 × 360) 60 Hz: 30 fps (1280 × 720, 640 × 480, 640 × 360)
Third Stream	50 Hz: 1 fps (640 × 360) 60 Hz: 1 fps (640 × 360)
Video Compression	Main stream: H.265/H.264/H.265+/H.264+ Sub-stream: H.265/H.264/MJPEG Third stream: H.265/H.264
Video Bit Rate	32 Kbps to 16 Mbps
H.264 Type	Baseline Profile/Main Profile/High Profile
H.265 Type	Main Profile
Region of Interest (ROI)	1 fixed region for main stream and sub-stream
<b>Audio</b>	
Audio Compression	G.711ulaw/G.711alaw/G.722.1/G.726/MP2L2/PCM/AAC
Audio Bit Rate	64 Kbps(G.711 ulaw/G.711 alaw)/16 Kbps(G.722.1)/16 Kbps(G.726)/32 to160 Kbps(MP2L2)/16 to 64 Kbps(AAC)
Audio Sampling Rate	8 kHz/16 kHz
Environment Noise Filtering	Yes
<b>Network</b>	
Protocols	TCP/IP, ICMP, HTTP, HTTPS, FTP, DHCP, DNS, DDNS, RTP, RTSP, RTCP, NTP, UPnP™, SMTP, IGMP, 802.1X, QoS, IPv6, Bonjour, IPv4, UDP, SSL/TLS

Simultaneous Live View	Up to 6 channels
API	Open Network Video Interface, ISAPI
User/Host	Up to 32 users. 3 levels: administrator, operator and user
Client	iVMS-4200, Hik-Connect
Web Browser	Plug-in required live view: IE 10+ Plug-in free live view: Chrome 57.0+, Firefox 52.0+ Local service: Chrome 57.0+, Firefox 52.0+
<b>Image</b>	
Image Settings	Saturation, brightness, contrast, sharpness, AGC, white balance adjustable by client software or web browser
Day/Night Switch	Day, Night, Auto, Schedule
Wide Dynamic Range (WDR)	120 dB
Image Enhancement	BLC, HLC, 3D DNR
<b>Interface</b>	
Ethernet Interface	1 RJ45 10 M/100 M self-adaptive Ethernet port
Almacenamiento a bordo	Ranura para tarjeta de memoria incorporada, compatible con tarjeta microSD, hasta 256 GB
Audio	1 input (line in), two-core terminal block, max. input amplitude: 3.3 Vpp, input impedance: 4.7 K $\Omega$ , interface type: non-equilibrium 1 output (line out), two-core terminal block, max. output amplitude: 3.3 Vpp, output impedance: 100 $\Omega$ , interface type: non-equilibrium
Alarm	1 input, 1 output, (max. 12 VDC, 30 mA)
Reset Key	Yes
<b>Eventos</b>	
Evento Basico	Detección de movimiento, alarma de manipulación de vídeo, excepción
Evento Inteligente	Detección de cruce de línea, detección de intrusión
Linkage	Cargar en FTP/tarjeta de memoria, notificar al centro de vigilancia, enviar correo electrónico, activar grabación, activar captura, activar salida de alarma
<b>General</b>	
Alimentacion	12 VDC $\pm$ 25%, 0.9 A, max. 11 W, $\varnothing$ 5.5 mm coaxial power plug PoE: 802.3af, Class 3, 36 V to 57 V, 0.36 A to 0.23 A, max. 12.9 W
Material	Metal
Dimension	$\varnothing$ 105 mm $\times$ 294.5 mm (4.1" $\times$ 11.6")
Package Dimension	386 mm $\times$ 156 mm $\times$ 155 mm (15.2" $\times$ 6.1" $\times$ 6.1")
Weight	Approx. 1050 g (2.3 lb.)
With Package Weight	Approx. 1500 g (3.3 lb.)
Storage Conditions	-30 $^{\circ}$ C to 60 $^{\circ}$ C (-22 $^{\circ}$ F to 140 $^{\circ}$ F). Humidity: 95% or less (non-condensing)
Startup and Operating Conditions	-30 $^{\circ}$ C to 60 $^{\circ}$ C (-22 $^{\circ}$ F to 140 $^{\circ}$ F). Humidity: 95% or less (non-condensing)
Language	English, Ukrainian
General Function	Anti-flicker, heartbeat, mirror, password protection, privacy mask, watermark, IP address filter

Approval	
EMC	FCC SDoC (47 CFR Part 15, Subpart B); CE-EMC (EN 55032: 2015, EN 61000-3-2:2019, EN 61000-3-3:2013+A1:2019, EN 50130-4: 2011 +A1: 2014); KC (KN 32: 2015, KN 35: 2015)
Safety	UL (UL 62368-1) CB (IEC 62368-1: 2014+A11) CE-LVD (EN 62368-1: 2014/A11: 2017) BIS (IS 13252 (Part 1): 2010/IEC 60950-1: 2005)
Environment	CE-RoHS (2011/65/EU); WEEE (2012/19/EU); Reach (Regulation (EC) No 1907/2006)
Protection	IP67 (IEC 60529-2013)

### ▪ Available Model

DS-2CD3651G0-IZS (2.7- to 3.5 mm)

### ▪ Typical Application

Hikvision products are classified into three levels according to their anti-corrosion performance. Refer to the following description to choose for your using environment.

This model has NO SPECIFIC PROTECTION.

Level	Description
Top-level protection	Hikvision products at this level are equipped for use in areas where professional anti-corrosion protection is a must. Typical application scenarios include coastlines, docks, chemical plants, and more.
Moderate protection	Hikvision products at this level are equipped for use in areas with moderate anti-corrosion demands. Typical application scenarios include coastal areas about 2 kilometers (1.24 miles) away from coastlines, as well as areas affected by acid rain.
No specific protection	Hikvision products at this level are equipped for use in areas where no specific anti-corrosion protection is needed.

### ▪ Dimension

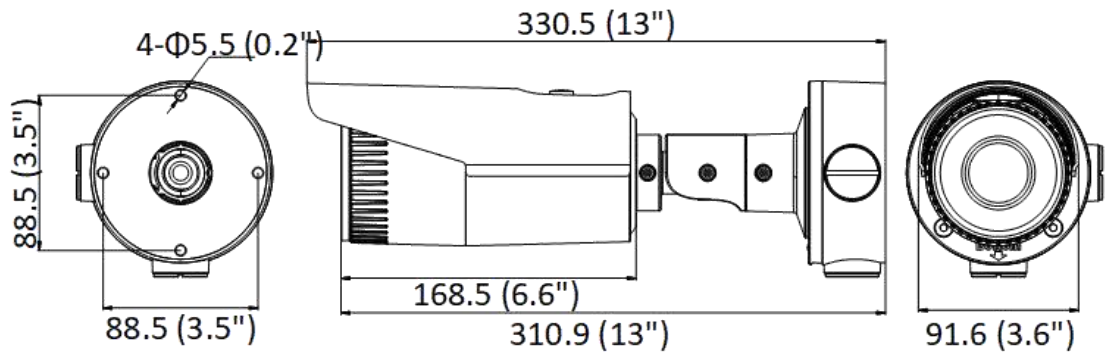

With Junction Box



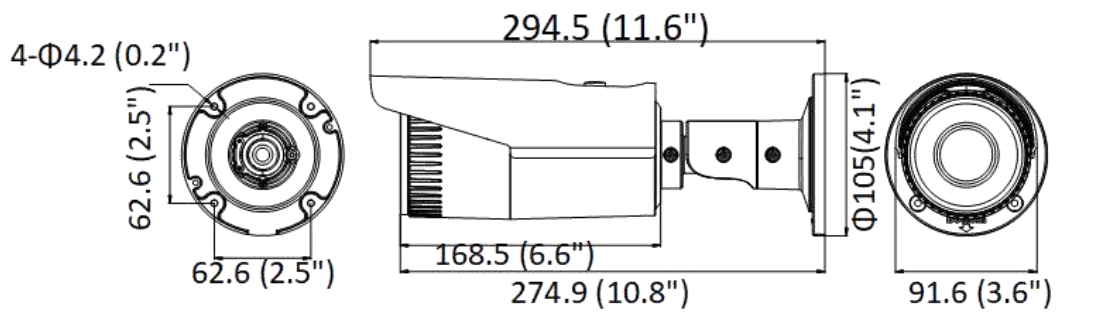

Unit: mm (inch)









Without Junction Box

Unit: mm (inch)





**▪ Accessory****▪ Optional**

<b>DS-1280ZJ-S Junction Box</b>	<b>DS-1276ZJ-SUS Corner Mount</b>	<b>DS-1275ZJ-SUS Vertical Pole Mount</b>	<b>DS-1260ZJ Junction Box</b>
			

Distributed by

[www.rosarioseguridad.com.ar](http://www.rosarioseguridad.com.ar) [ventas@rosarioseguridad.com.ar](mailto:ventas@rosarioseguridad.com.ar)  +54 9 341 6708000  +54 9 341 6799822 [rosarioseguridadok](#) [Rosario Seguridad](#) [Rosario Seguridad](#)

Grupo Instaladores

 <https://www.facebook.com/groups/591852618012744/>  +54 9 341 6591429  +54 9 341 4577532

Avenida Pellegrini 4820 - Rosario - Santa Fe - Argentina

**HIKVISION®****Headquarters**No.555 Qianmo Road, Binjiang District,  
Hangzhou 310051, China  
T +86-571-8807-5998  
[overseasbusiness@hikvision.com](mailto:overseasbusiness@hikvision.com)**Hikvision USA**  
T +1-909-895-0400  
[sales.usa@hikvision.com](mailto:sales.usa@hikvision.com)**Hikvision Australia**  
T +61-2-8599-4233  
[salesau@hikvision.com](mailto:salesau@hikvision.com)**Hikvision India**  
T +91-22-28469900  
[sales@pramahikvision.com](mailto:sales@pramahikvision.com)**Hikvision Canada**  
T +1-866-200-6690  
[sales.canada@hikvision.com](mailto:sales.canada@hikvision.com)**Hikvision Thailand**  
T +662-275-9949  
[sales.thailand@hikvision.com](mailto:sales.thailand@hikvision.com)**Hikvision Europe**  
T +31-23-5542770  
[sales.eu@hikvision.com](mailto:sales.eu@hikvision.com)**Hikvision Italy**  
T +39-0438-6902  
[Info.it@hikvision.com](mailto:Info.it@hikvision.com)**Hikvision Brazil**  
T +55 11 3318-0050  
[Latam.support@hikvision.com](mailto:Latam.support@hikvision.com)**Hikvision Turkey**  
T +90 [216]521 7070- 7074  
[sales.tr@hikvision.com](mailto:sales.tr@hikvision.com)**Hikvision Malaysia**  
T +601-7652-2413  
[sales.my@hikvision.com](mailto:sales.my@hikvision.com)**Hikvision UK & Ireland**  
T +01628-902140  
[sales.uk@hikvision.com](mailto:sales.uk@hikvision.com)**Hikvision South Africa**  
Tel: +27 (10) 0351172  
[sale.africa@hikvision.com](mailto:sale.africa@hikvision.com)**Hikvision France**  
T +33(0)1-85-330-450  
[info.fr@hikvision.com](mailto:info.fr@hikvision.com)**Hikvision Kazakhstan**  
T +7-727-9730667  
[nikia.panfilov@hikvision.ru](mailto:nikia.panfilov@hikvision.ru)**Hikvision Vietnam**  
T +84-974270888  
[sales.vt@hikvision.com](mailto:sales.vt@hikvision.com)**Hikvision UAE**  
T +971-4-4432090  
[salesme@hikvision.com](mailto:salesme@hikvision.com)**Hikvision Singapore**  
T +65-6684-4718  
[sg@hikvision.com](mailto:sg@hikvision.com)**Hikvision Spain**  
T +34-91-737-16-55  
[info.es@hikvision.com](mailto:info.es@hikvision.com)**Hikvision Tashkent**  
T +99-87-1238-9438  
[uzb@hikvision.ru](mailto:uzb@hikvision.ru)**Hikvision Hong Kong**  
T +852-2151-1761  
[info.hk@hikvision.com](mailto:info.hk@hikvision.com)**Hikvision Russia**  
T +7-495-669-67-99  
[saleru@hikvision.com](mailto:saleru@hikvision.com)**Hikvision Korea**  
T +82-[0]31-731-8817  
[sales.korea@hikvision.com](mailto:sales.korea@hikvision.com)**Hikvision Poland**  
T +48-22-460-01-50  
[info.pl@hikvision.com](mailto:info.pl@hikvision.com)**Hikvision Indonesia**  
T +62-21-2933759  
[Sales.Indonesia@hikvision.com](mailto:Sales.Indonesia@hikvision.com)**Hikvision Colombia**  
[sales.colombia@hikvision.com](mailto:sales.colombia@hikvision.com)