



# TURBO HD TVI Bullet & Turret Camera

## User Manual

**UD03589B**

### **User Manual**

Thank you for purchasing our product. If there are any questions, or requests, do not hesitate to contact the dealer.

This manual applies to the model listed below.

Type	Model
Type I	DS-2CE16C0T-IRF/IRPF DS-2CE16D0T-IRF/IRPF
Type II	DS-2CE56C0T-IRMF DS-2CE56D0T-IRMF
Type III	DS-2CE56C0T-IRF/IRPF DS-2CE56D0T-IRF/IRPF

This manual may contain several technically incorrect places or printing errors, and the content is subject to change without notice. The updates will be added to the new version of this manual. We will readily improve or update the products or procedures described in the manual.

0100001061107

## Regulatory Information

### FCC Information

**FCC compliance:** This equipment has been tested and found to comply with the limits for a Class A digital device, pursuant to part 15 of the FCC Rules. These limits are designed to provide reasonable protection against harmful interference when the equipment is operated in a commercial environment. This equipment generates, uses, and can radiate radio frequency energy and, if not installed and used in accordance with the instruction manual, may cause harmful interference to radio communications. Operation of this equipment in a residential area is likely to cause harmful interference in which case the user will be required to correct the interference at his own expense.

### FCC Conditions

This device complies with part 15 of the FCC Rules. Operation is subject to the following two conditions:

1. This device may not cause harmful interference.
2. This device must accept any interference received, including interference that may cause undesired operation

### EU Conformity Statement



This product and - if applicable - the supplied accessories too are marked with "CE" and comply therefore with the applicable harmonized European

standards listed under the EMC Directive 2014/30/EU, the RoHS Directive 2011/65/EU.



2012/19/EU (WEEE directive): Products marked with this symbol cannot be disposed of as unsorted municipal waste in the European Union. For proper recycling, return this product to your local supplier upon the purchase of equivalent new

equipment, or dispose of it at designated collection points. For more information see: [www.recyclethis.info](http://www.recyclethis.info).

### Industry Canada ICES-003 Compliance

This device meets the CAN ICES-3 (A)/NMB-3(A) standards requirements.

## Safety Instruction

These instructions are intended to ensure that user can use the product correctly to avoid danger or property loss.

The precaution measure is divided into “Warnings” and “Cautions”

**Warnings:** Serious injury or death may occur if any of the warnings are neglected.

**Cautions:** Injury or equipment damage may occur if any of the cautions are neglected.

	
<b>Warnings</b> Follow these safeguards to prevent serious injury or death.	<b>Cautions</b> Follow these precautions to prevent potential injury or material damage.



### Warnings

- In the use of the product, you must be in strict compliance with the electrical safety regulations of the nation and region.
- Refer to technical specifications for detailed information.
- Input voltage should meet both the SELV (Safety Extra Low Voltage) and the Limited Power Source with 12 V DC according to the IEC60950-1 standard. Refer to technical specifications for detailed information.
- Do not connect several devices to one power adapter as adapter overload may cause over-heating or a fire hazard.
- Make sure that the plug is firmly connected to the power socket.
- When the product is mounted on wall or ceiling, the device shall be firmly fixed.
- If smoke, odor or noise rise from the device, turn off the power at once and unplug the power cable, and then contact the service center.
- If the product does not work properly, contact your dealer or the nearest service center. Never attempt to disassemble the camera yourself. (We shall not assume any responsibility for problems caused by unauthorized repair or maintenance.)



### Cautions

- Make sure the power supply voltage is correct before using the camera.
- Do not drop the camera or subject it to physical shock.
- Do not touch sensor modules with fingers. If cleaning is necessary, use clean cloth with a bit of ethanol and wipe it gently.
- Do not aim the camera at the sun or extra bright places. Blooming or smearing may occur otherwise (which is not a malfunction), and affect the endurance of sensor at the same time.

- The sensor may be burned out by a laser beam, so when any laser equipment is in using, make sure that the surface of sensor will not be exposed to the laser beam.
- Do not place the camera in extremely hot, cold, dusty or damp locations, and do not expose it to high electromagnetic radiation.
- To avoid heat accumulation, good ventilation is required for operating environment.
- Keep the camera away from liquid while in use.
- While in delivery, the camera shall be packed in its original packing, or packing of the same texture.

## Chapter 1 Introduction

### 1.1 Product Features

The camera is applicable for both indoor and outdoor conditions, and the application scenarios include road, warehouse, parking lot, office, campus, etc..

The main features are as follows:

- High performance CMOS sensor
- 1080p/720p resolution
- Auto white balance
- Auto electronic shutter
- Auto gain control (AGC)
- Switchable TVI/AHD/CVI/CVBS video output
- IR cut filter
- 3-axis adjustment

**Note:**

Type III camera is applicable for indoor only.

### 1.2 Overview

#### 1.2.1 Type I Camera Overview

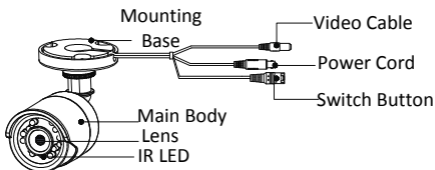

Figure 1. 1 Type I Camera Overview

**Note:**

Press the switch button for 5 seconds to switch the video output with TVI, AHD, CVI, and CVBS available.

## 1.2.2 Type II Camera Overview

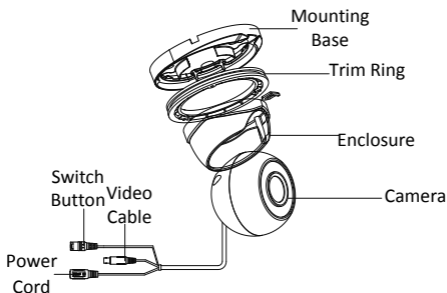

Figure 1. 2 Type II Camera Overview

### **Note:**

Press the switch button for 5 seconds to switch the video output with TVI, AHD, CVI, and CVBS available.

## 1.2.3 Type III Camera Overview

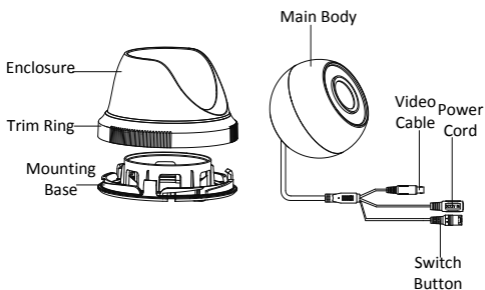

Figure 1. 3 Type III Camera Overview

### **Note:**

Click the switch button for 5 seconds to switch the video output with TVI, AHD, CVI, and CVBS available.

# Chapter 2 Installation

## 2.1 Installation Preparation

### **Before you start:**

- Make sure that the device in the package is in good condition and all the assembly parts are included.
- Make sure that all the related equipment is power-off during the installation.
- Check the specification of the products for the installation environment.
- Check whether the power supply is matched with your power output to avoid damage.
- Make sure the wall is strong enough to withstand three times the weight of the camera and the mounting bracket.
- If the wall is cement, you need to insert expansion bolts before you install the camera. If the wall is wooden, you can use self-tapping screws to secure the camera.
- If the product does not function properly, contact your dealer or the nearest service center. Do NOT

disassemble the camera for repair or maintenance by yourself.

## 2.2 Installation of Type I Camera

### Steps:

1. Attach the drill template to the ceiling.
2. Drill the screw holes according to the drill template, and the cable hole (optional) on the ceiling.

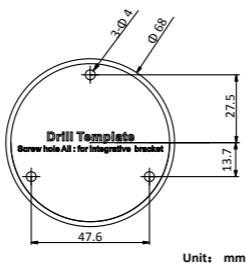

Figure 2. 1 Drill Template

### Note:

Cable hole is required when adopting ceiling outlet to route the cable.

3. Attach the mounting base of the type I camera to the ceiling and secure the camera with supplied screws.

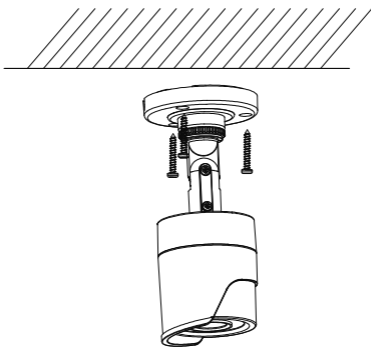

Figure 2. 2 Secure the camera to the ceiling

### Note:

- In the supplied screw package, both self-tapping screws and expansion blots are contained.
  - If the wall is cement, expansion blots are required to fix the camera. If the wall is wooden, self-tapping screws are required.
4. Route the cables through the cable hole (optional), or the side opening.
  5. Connect the corresponding power cord and video cable.
  6. Power on the camera to check whether the image on the monitor is gotten from the optimum angle. If not, adjust the camera according to the figure below to get an optimum angle.
    - 1). Loosen the No.1 adjusting screw to adjust the pan position ( $0^{\circ}$  to  $360^{\circ}$ ).
    - 2). Tighten the No.1 adjusting screw.

- 3). Loosen the No.2 adjusting screw to adjust the tilting position ( $0^{\circ}$  to  $180^{\circ}$ ).
- 4). Tighten the No. 2 adjusting screw.
- 5). Loosen the No.3 adjusting screw to adjust the rotation position ( $0^{\circ}$  to  $360^{\circ}$ ).
- 6). Tighten the No.3 adjusting screw.

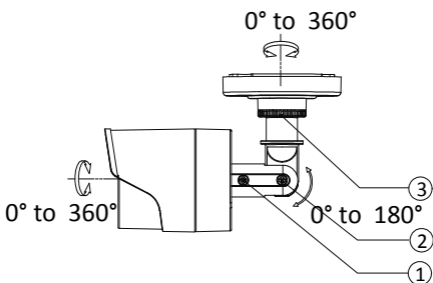

Figure 2. 3 3-Axis Adjustment

## 2.3 Installation of Type II camera

### Steps:

1. Use the hex wrench to loosen the screw, and remove the mounting base from the camera body, shown as the figure 2.4.

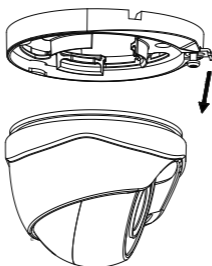

Figure 2. 4 Disassemble the Camera

2. Attach the drill template (supplied) to the place where you want to install the camera, and then drill the screw holes according to the drill template, and the cable hole (optional) on the ceiling.

### Note:

Cable hole is required when adopting ceiling outlet to route the cable.

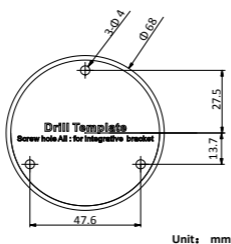

Figure 2. 5 Drill Template

3. Attach the mounting base to the ceiling and secure them with supplied screws

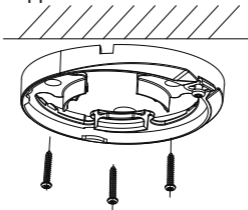

Figure 2. 6 Attach the Mounting Base to the Ceiling

**Note:**

- In the supplied screw package, both self-tapping screws and expansion blots are contained.
  - If the wall is cement, expansion blots are required to fix the camera. If the wall is wooden, self-tapping screws are required.
4. Route the cables through the cable hole (optional), or the side opening.
  5. Pull out the clip plate and secure the camera with the trim ring to the mounting base.
  6. Push the clip plate in and tighten the screw to secure the camera with the mounting base.

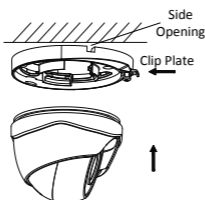

Figure 2. 7 Secure the Camera with Mounting Base

7. Connect the corresponding cables, such as power cord, and video cable.
8. Power on the camera to check whether the image on the monitor is gotten from the optimum angle. If not, adjust the camera according to the figure below to get an optimum angle.
  - 1). Hold the camera body and rotate the enclosure to adjust the pan position [0° to 360°].
  - 2). Move the camera body up and down to adjust the tilt position [0° to 75°].
  - 3). Rotate the camera body to adjust the rotation position [0° to 360°].

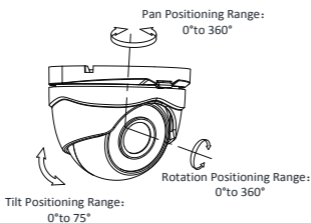

Figure 2. 8 3-axis Adjustment



## 2.4 Installation of Type III Camera

### Steps:

1. Attach the drill template (supplied) to the place where you want to install the camera, and then drill the screw holes and the cable hole (optional) according to the drill template on the ceiling.

### Note:

Cable hole is required when adopting ceiling outlet to route the cable.

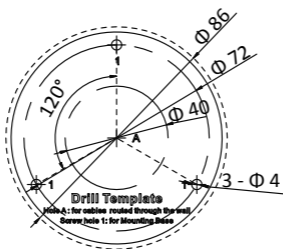

Figure 2. 9 Drill Template

2. Attach the mounting base to the ceiling and secure them with supplied screws

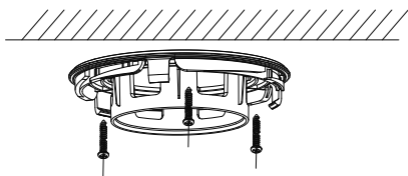
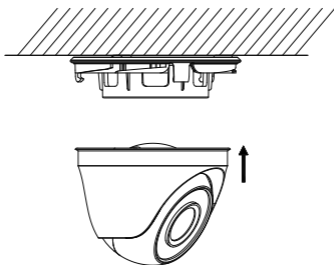

Figure 2. 10 Attach the Mounting Base to the Ceiling

### Note:

- In the supplied screw package, both self-tapping screws and expansion blots are contained.
  - If the wall is cement, expansion blots are required to fix the camera. If the wall is wooden, self-tapping screws are required.
3. Route the cables through the cable hole (optional), or the side opening.
  4. Align the camera with the mounting base, secure the camera with the mounting base, and fix the trim ring to the camera.



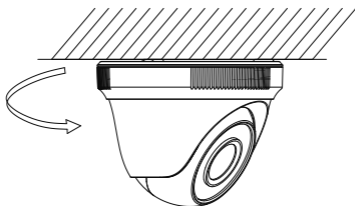
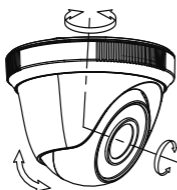

Figure 2. 11 Secure the Camera with Mounting Base

5. Connect the corresponding cables, such as power cord, and video cable.
6. Power on the camera to check whether the image on the monitor is gotten from the optimum angle. If not, adjust the camera according to the figure below to get an optimum angle.
  - 1). Hold the camera body and rotate the enclosure to adjust the pan position [0° to 360°].
  - 2). Move the camera body up and down to adjust the tilt position [0° to 75°].
  - 3). Rotate the camera body to adjust the rotation position [0° to 360°].

Pan Positioning Range:  
0° to 360°



Rotation Positioning Range:  
0° to 360°

Tilt Positioning Range:  
0° to 75°

Figure 2. 12 3-axis Adjustment