

## DS-K1T673DWX

### Terminal de reconocimiento de rostro profesional



El terminal de reconocimiento facial es un tipo de dispositivo de control de acceso. Se puede aplicar ampliamente en múltiples escenarios, como empresas, estaciones, viviendas, fábricas, escuelas, campus, etc.

- Pantalla táctil LCD de 7 pulgadas, lente gran angular de 2 megapíxeles
- Distancia de reconocimiento: 0,3 a 3 m
- Duración del reconocimiento facial <0,2 s/ Usuario
- Tasa de precisión de reconocimiento facial  $\geq 99\%$
- Tarjeta Mifare integrada, tarjeta Felica y módulo de lectura de tarjetas DESfire (Presenta la tarjeta en la pantalla para autenticar)
- Detección de máscara facial
- Capacidad para 10 000 caras, capacidad para 10 000 huellas dactilares (con módulo de huellas dactilares), capacidad para 50 000 tarjetas y capacidad para 150 000 eventos
- Compatible con ISAPI, ISUP 5.0, TCP/IP (IPv4 e IPv6)
- Admite el reconocimiento de una sola persona y varias personas a la vez(hasta 5 personas)

## ▪ Especificacion

| <b>System</b>                  |  |
|--------------------------------|--|
| Operation system               | Linux                                    |
| <b>Display</b>                 |  |
| Size                           | 7-inch                                   |
| Type                           | Touch screen                             |
| <b>Video</b>                   |  |
| FOV                            | HFOV= 75.5°; VFOV= 41.5°; DFOV= 87°      |
| Pixel                          | 2 MP                                     |
| Lens                           | Dual-lens                                |
| Video standard                 | PAL (Default)/NTSC                       |
| <b>Network</b>                 |  |
| Wired network                  | Support 10/100/1000 Mbps self-adaptive   |
| Wi-Fi                          | Support                                  |
| <b>Interface</b>               |  |
| Alarm input                    | 1  |
| Alarm output                   | 1  |
| USB                            | 1 (For Module)                           |
| Audio Output Interface         | 1 (3.5 mm)                               |
| Network interface              | 1  |
| RS-485                         | 1  |
| Wiegand                        | 1  |
| Lock output                    | 1  |
| Exit button                    | 1  |
| Door contact input             | 1  |
| TAMPER                         | 1  |
| <b>Capacity</b>                |  |
| Card capacity                  | 50,000                                   |
| Face capacity                  | 10,000                                   |
| Event capacity                 | 150,000                                  |
| <b>Authentication</b>          |  |
| Face recognition accuracy rate | ≥ 99%                                    |
| Card type                      | Mifare 1 card, DESfire card, Felica card |
| Card reading distance          | 0 to 3 cm                                |
| Card reading duration          | < 1 s                                    |
| Face recognition duration      | < 0.2 s per person                       |
| Face recognition distance      | 0.3 to 3 m                               |
| <b>Function</b>                |  |
| Two-way audio                  | Support                                  |
| Time synchronization           | Support                                  |
| Face anti-spoofing             | Support                                  |
| Live view                      | Support                                  |
| Audio prompt                   | Support                                  |
| <b>General</b>                 |  |
| Power supply                   | 12 VDC to 24 VDC/2 A                     |

|                     |  |
|---------------------|--|
| Working temperature | -30 °C to 60 °C (-22 °F to 140 °F)   |
| Working humidity    | 0 to 90% (no condensing)   |
| Protective level    | IP65   |
| Dimensions          | 110.5 mm × 209.2 mm × 24 mm (4.35" × 8.24" × 0.94")  |
| Language            | English, Spanish (South America), Arabic, Thai, Indonesian, Russian, Vietnamese, Portuguese (Brazil), Japanese, Korean |
| Weight              | Gross Weight: 1.06 kg (2.34 lb)<br>Net Weight: 0.57 kg (1.26 lb)   |

**▪ Modelo disponible**



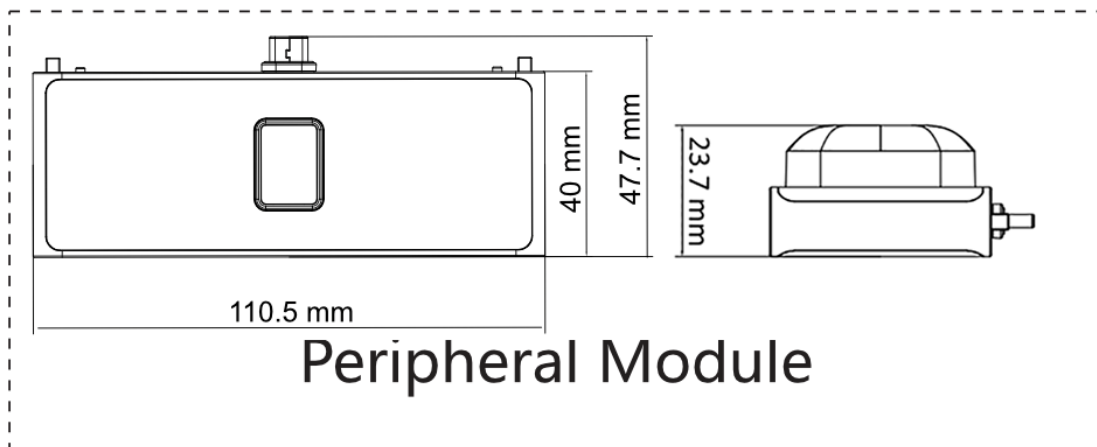
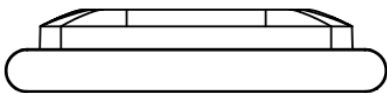
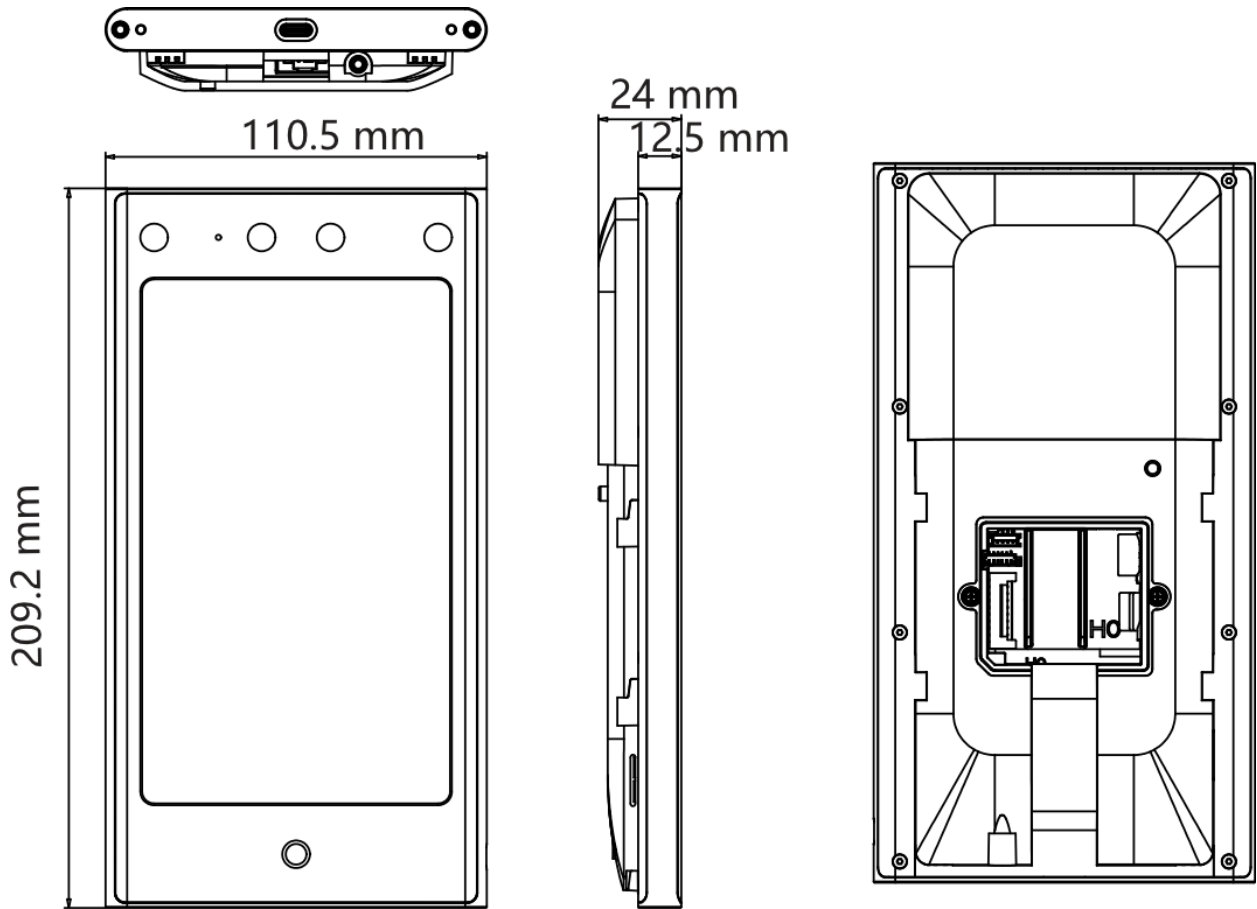

DS-K1T673DWX

▪ Dimensiones











## Accesorios

### ▪ Opcional

| DS-KAB673-BQR   | DS-KAB673-FB  | DS-KAB673-B   | DS-KAB673-FBQR   | DS-K3AP122  |
|---|---|---|--|---|
|  |  |  |  |  |

Grupo Instaladores

- |  |  |   |
|--|--|---|
|  <a href="mailto:ventas@rosarioseguridad.com.ar">ventas@rosarioseguridad.com.ar</a> |  <a href="#">rosarioseguridadok</a> |  <a href="https://www.facebook.com/groups/591852618012744/">https://www.facebook.com/groups/591852618012744/</a> |
|  +54 9 341 6708000  |  Rosario Seguridad                  |  +54 9 341 6591429   |
|  +54 9 341 6799822  |  Rosario Seguridad                  |  +54 9 341 4577532   |

**Avenida Presidente Perón 3998 - Rosario - Santa Fe - Argentina**

**Headquarters**

No.555 Qianmo Road, Binjiang District,  
Hangzhou 310051, China  
T +86-571-8807-5998  
[www.hikvision.com](http://www.hikvision.com)



Follow us on social media to get the latest product and solution information.

