

**DS-K1T321 Series
Terminal de reconocimiento facial**

Guia Rapida

UD31158B

©2022 Hangzhou Hikvision Digital Technology Co., Ltd. All rights reserved.

About this Manual

The Manual includes instructions for using and managing the Product. Pictures, charts, images and all other information hereinafter are for description and explanation only. The information contained in the Manual is subject to change, without notice, due to firmware updates or other reasons. Please find the latest version of this Manual at the Hikvision website (<https://www.hikvision.com/>).

Please use this Manual with the guidance and assistance of professionals trained in supporting the Product.

Trademarks

HIKVISION and other Hikvision's trademarks and logos are the properties of Hikvision in various jurisdictions. Other trademarks and logos mentioned are the properties of their respective owners.

Disclaimer

TO THE MAXIMUM EXTENT PERMITTED BY APPLICABLE LAW, THIS MANUAL AND THE PRODUCT DESCRIBED, WITH ITS HARDWARE, SOFTWARE AND FIRMWARE, ARE PROVIDED "AS IS" AND "WITH ALL FAULTS AND ERRORS". HIKVISION MAKES NO WARRANTIES, EXPRESS OR IMPLIED, INCLUDING WITHOUT LIMITATION, MERCHANTABILITY, SATISFACTORY QUALITY, OR FITNESS FOR A PARTICULAR PURPOSE. THE USE OF THE PRODUCT BY YOU IS AT YOUR OWN RISK. IN NO EVENT WILL HIKVISION BE LIABLE TO YOU FOR ANY SPECIAL, CONSEQUENTIAL, INCIDENTAL, OR INDIRECT DAMAGES, INCLUDING, AMONG OTHERS, DAMAGES FOR LOSS OF BUSINESS PROFITS, BUSINESS INTERRUPTION, OR LOSS OF DATA, CORRUPTION OF SYSTEMS, OR LOSS OF DOCUMENTATION, WHETHER BASED ON BREACH OF CONTRACT, TORT (INCLUDING NEGLIGENCE), PRODUCT LIABILITY, OR OTHERWISE, IN CONNECTION WITH THE USE OF THE PRODUCT, EVEN IF HIKVISION HAS BEEN ADVISED OF THE POSSIBILITY OF SUCH DAMAGES OR LOSS.

YOU ACKNOWLEDGE THAT THE NATURE OF THE INTERNET PROVIDES FOR INHERENT SECURITY RISKS, AND HIKVISION SHALL NOT TAKE ANY RESPONSIBILITIES FOR ABNORMAL OPERATION, PRIVACY LEAKAGE OR OTHER DAMAGES RESULTING FROM CYBER-ATTACK, HACKER ATTACK, VIRUS INFECTION, OR OTHER INTERNET SECURITY RISKS; HOWEVER, HIKVISION WILL PROVIDE TIMELY TECHNICAL SUPPORT IF REQUIRED.

YOU AGREE TO USE THIS PRODUCT IN COMPLIANCE WITH ALL APPLICABLE LAWS, AND YOU ARE SOLELY RESPONSIBLE FOR ENSURING THAT YOUR USE CONFORMS TO THE APPLICABLE LAW. ESPECIALLY, YOU ARE RESPONSIBLE, FOR USING THIS PRODUCT IN A MANNER THAT DOES NOT INFRINGE ON THE RIGHTS OF THIRD PARTIES, INCLUDING WITHOUT LIMITATION, RIGHTS OF PUBLICITY, INTELLECTUAL PROPERTY RIGHTS, OR DATA PROTECTION AND OTHER PRIVACY RIGHTS. YOU SHALL NOT USE THIS PRODUCT FOR ANY PROHIBITED END-USES, INCLUDING THE DEVELOPMENT OR PRODUCTION OF WEAPONS OF MASS DESTRUCTION, THE DEVELOPMENT OR PRODUCTION OF CHEMICAL OR BIOLOGICAL WEAPONS, ANY ACTIVITIES IN THE CONTEXT RELATED TO ANY NUCLEAR EXPLOSIVE OR UNSAFE NUCLEAR FUEL-CYCLE, OR IN SUPPORT OF HUMAN RIGHTS ABUSES.

IN THE EVENT OF ANY CONFLICTS BETWEEN THIS MANUAL AND THE APPLICABLE LAW, THE LATTER PREVAILS.

Data Protection

During the use of device, personal data will be collected, stored and processed. To protect data, the development of Hikvision devices incorporates privacy by design principles. For example, for device with facial recognition features, biometrics data is stored in your device with encryption method; for fingerprint device, only fingerprint template will be saved, which is impossible to reconstruct a fingerprint image.

As data controller, you are advised to collect, store, process and transfer data in accordance with the applicable data protection laws and regulations, including without limitation, conducting security controls to safeguard personal data, such as, implementing reasonable administrative and physical security controls, conduct periodic reviews and assessments of the effectiveness of your security controls.

Scan the QR code to get the user manual for detailed information.



1 Instalacion

Installation Environment:

- Indoor use only.
- Avoid backlight, direct sunlight, and indirect sunlight.
- For Better recognition, there should be light source in or near the installation environment.
- The minimum bearing weight of the wall or other places should be 3 times heavier than the device weight.

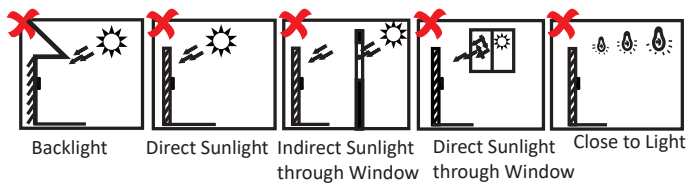

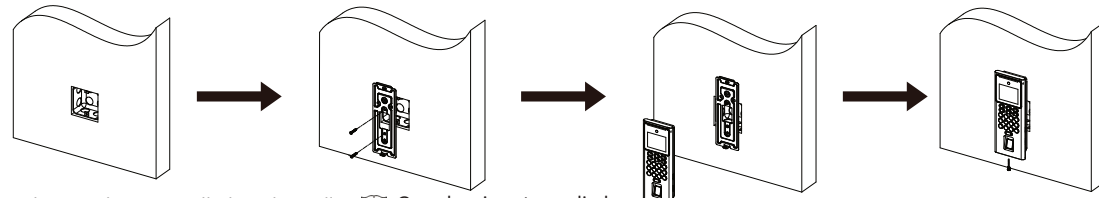

Install with Mounting Plate



- 1 Make sure the gang box is installed on the wall.  Gang box is not supplied.
- 2 Secure the mounting plate on the gang box with two supplied screws (SC-KA4X25). Route the cable through the cable hole, wire the cables and insert the cables in the gang box.
- 3 Align the device with the mounting plate, and secure the device on the mounting plate with 1 supplied screw (SC-CM3X8-B-T10-SUS).

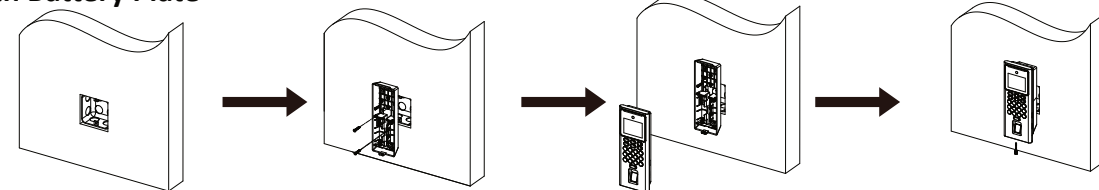

Install with Battery Plate

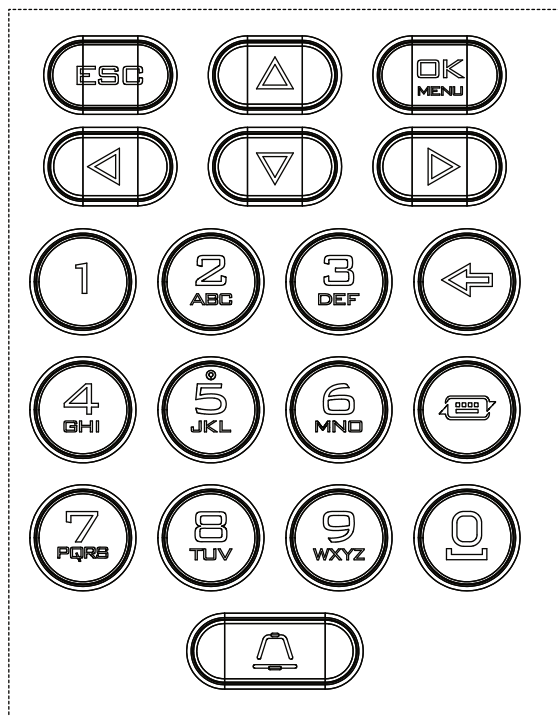

- 1 Make sure the gang box is installed on the wall.  Gang box and battery plate are not supplied. You can purchase separately.
- 2 Secure the battery plate on the gang box with two supplied screws (SC-KA4X25). Route the cable through the cable hole, wire the cables and insert the cables in the gang box.
- 3 Align the device with the mounting plate, and secure the device on the battery plate with 1 supplied screw (SC-CM4X14-5T10-SUSS).

2.2 Descripcion teclado



Key	Description
Numeric Key	0~9. Digits, letters, and characters can be entered in the textbox via the numeric keys. 0 is reused as space bar when no digits enter.
Direction Key	Control four directions: front, back, left, and right.
ESC	Exit key. Exit the current page or return to the previous page.
OK	In the standby page, hold to enter the administrator login interface, and press to confirm. Used as confirmation and selection key after login.
	Delete key. Delete textbox contents.
	Input method shifting key.
	Door bell.



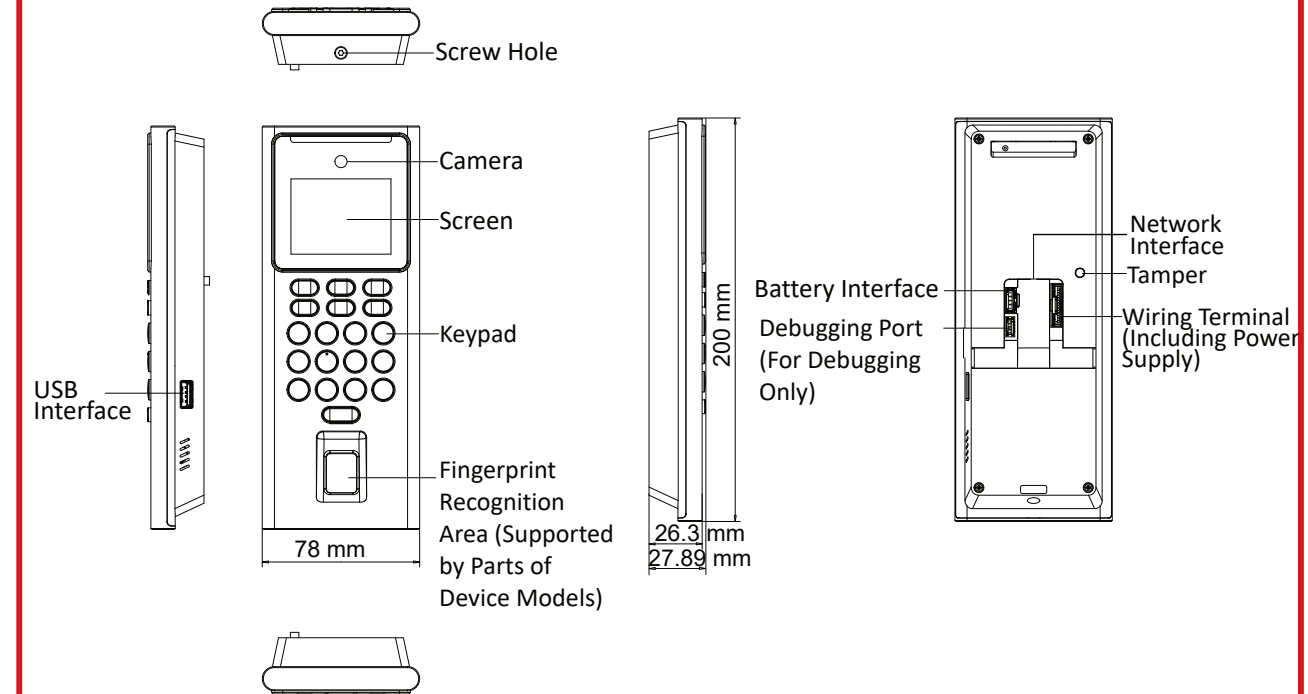





2.1 Apariencia

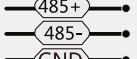

 The pictures here are for reference only.

3.1 Cableado (Normal)

Wiring Terminal Description

Power In	Red Black		 Power Adapter
Lock	White/Purple White/Yellow		 Electric Dropbolt / Electric Strike
	White/Red Yellow/Green Black		
RS-485	Yellow Blue Black		 Secure Door Control Unit Card Reader
			
Bell	Green White		 Bell

3.2 Cableado del dispositivo



Device Wiring

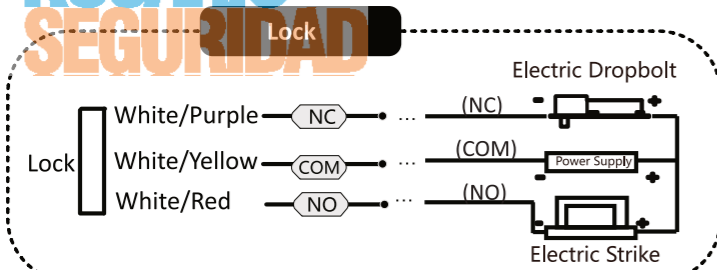

Door Contact

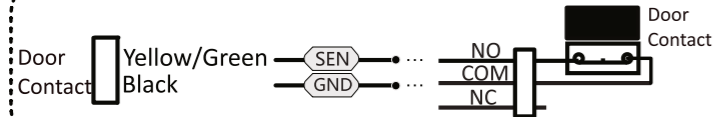

Exit Button

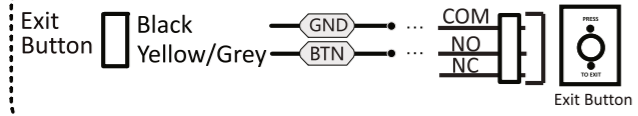

- When connecting door contact and exit button, the device and the RS-485 card reader should use the same common ground connection.
- The suggested external power supply for door lock is 12 V, 1 A.
- The suggested external power supply for Wiegand card reader is 12 V, 1 A.
- Do not wire the device to the electric supply directly.

3.3 Cableado del dispositivo (con unidad de control de puerta segura)

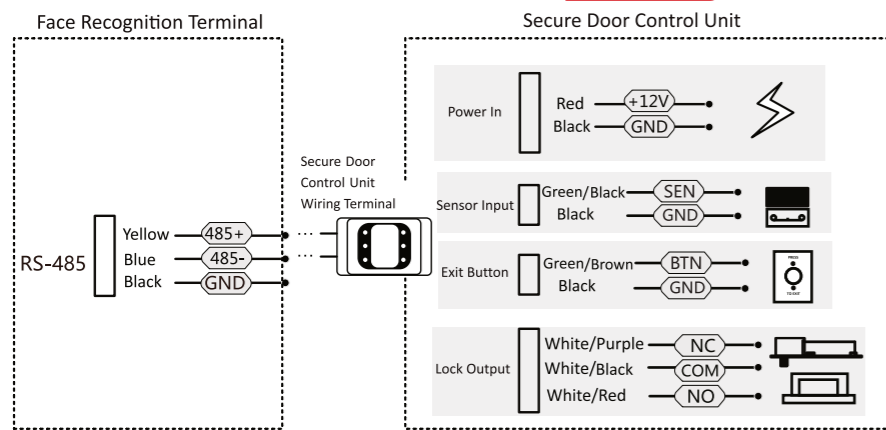

- The secure door control unit should connect to an external power supply separately. The suggested external power supply is 12 V, 0.5 A.
- For scenarios with high safety requirement, use the secure door control unit wiring first.
- You can ask the technical support to purchase for the secure door control unit separately.
- The picture here are parts of the wiring. For details, see the secure door control unit's user manual.

4 Operacion Rapida

Activation via Device

After powering on, you will enter the activation page. Enter password and press "OK" to confirm password.

- Press "☞" to shift input method.
- Characters containing admin and nimda are not supported to be set as activation password.

STRONG PASSWORD RECOMMENDED— We highly recommend you create a strong password of your own choosing (using a minimum of 8 characters, including upper case letters, lower case letters, numbers, and special characters) in order to increase the security of your product. And we recommend you reset your password regularly, especially in the high security system, resetting the password monthly or weekly can better protect your product.

Activation via AP

When the device is powered on for the first time, the device hotspot is enabled by default.

You can enable the WLAN on the mobile phone and search for a device hotspot to connect. The hotspot name is AP_device SN, and the password is device SN.

After the connection is successful, the mobile phone automatically switches to the mobile Web browser for activation and configuration.

The function is only supported by device with Wi-Fi function.

Steps Afterwards

After activating, you can select language, set password change type, set network parameters, access to Hik-Connect, set privacy, and set administrator.

Log in Home Page

Hold "OK", authenticate face, card, or press "▶" to enter the password, and log in the device to enter the home page.

Restore to Factory

Enter the home page, select "System Maintenance"-"Restore to Factory". All parameters will be restored to the factory settings. The system will reboot to take effect.

5 Agregar imagende cara

Tips When Collecting/ Comparing Face Picture

Expression

- Keep your expression naturally when collecting or comparing face pictures, just like the expression in the picture on the right.
- Do not wear hat, sunglasses, or other accessories that can affect the facial recognition function.
- Do not make your hair cover your eyes, ears, etc. and heavy makeup is not allowed.



Posture

In order to get a good quality and accurate face picture, position your face looking at the camera when collecting or comparing face picture.



Size

Make sure your face is in the middle of the collecting window.

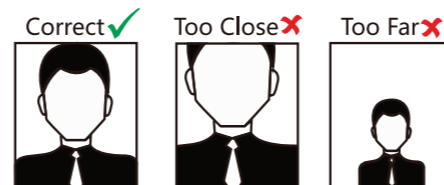

Positions When Collecting/ Comparing Face Picture

Biometric recognition products are not completely applicable to anti-spoofing environments. If you require a higher security level, use multiple authentication modes.

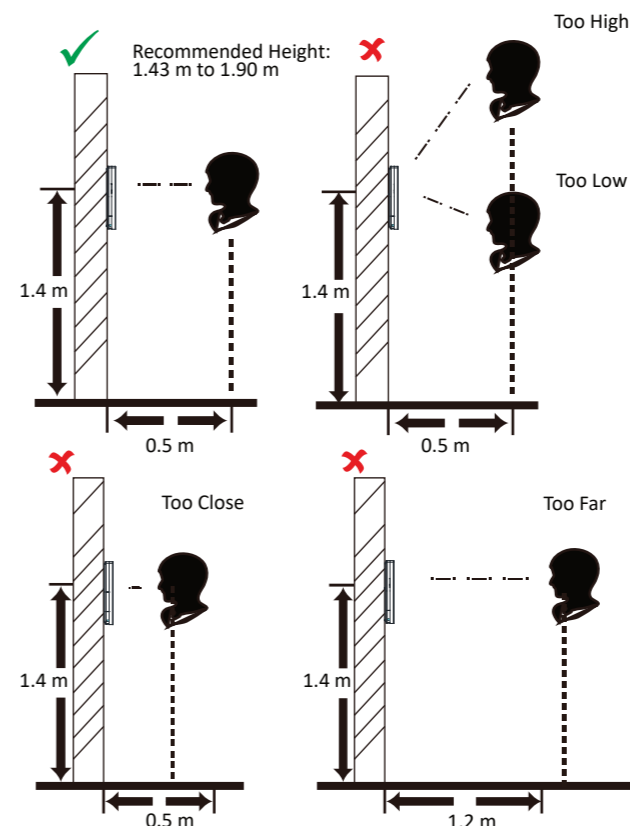

Regulatory Information

FCC Information
Please take attention that changes or modification not expressly approved by the party responsible for compliance could void the user's authority to operate the equipment.

FCC compliance:
This equipment has been tested and found to comply with the limits for a Class B digital device, pursuant to part 15 of the FCC Rules. These limits are designed to provide reasonable protection against harmful interference in a residential installation. This equipment generates, uses and can radiate radio frequency energy and, if not installed and used in accordance with the instructions, may cause harmful interference to radio communications. However, there is no guarantee that interference will not occur in a particular installation. If this equipment does cause harmful interference to radio or television reception, which can be determined by turning the equipment off and on, the user is encouraged to try to correct the interference by one or more of the following measures:
—Reorient or relocate the receiving antenna.
—Increase the separation between the equipment and receiver.
—Connect the equipment into an outlet on a circuit different from that to which the receiver is connected.
—Consult the dealer or an experienced radio/TV technician for help

This equipment should be installed and operated with a minimum distance 20cm between the radiator and your body.

FCC Conditions
This device complies with part 15 of the FCC Rules. Operation is subject to the following two conditions:
1. This device may not cause harmful interference.
2. This device must accept any interference received, including interference that may cause undesired operation.

EU Conformity Statement
This product and - if applicable - the supplied accessories too are marked with "CE" and comply therefore with the applicable harmonized European standards listed under the EMC Directive 2014/30/EU, RE Directive 2014/53/EU, the RoHS Directive 2011/65/EU

2006/66/EC (battery directive): This product contains a battery that cannot be disposed of as unsorted municipal waste in the European Union. See the product documentation for specific battery information. The battery is marked with this symbol, which may include lettering to indicate cadmium (Cd), lead (Pb), or mercury (Hg). For proper recycling, return the battery to your supplier or to a designated collection point. For more information see: www.recyclethis.info

2012/19/EU (WEEE directive): Products marked with this symbol cannot be disposed of as unsorted municipal waste in the European Union. For proper recycling, return this product to your local supplier upon the purchase of equivalent new equipment, or dispose of it at designated collection points. For more information see: www.recyclethis.info

Safety Instruction

- Warning**
 - In the use of the product, you must be in strict compliance with the electrical safety regulations of the nation and region.
 - Do not connect several devices to one power adapter as adapter overload may cause over-heat or fire hazard.
 - If smoke, odors or noise rise from the device, turn off the power at once and unplug the power cable, and then please contact the service center.
 - The socket-outlet shall be installed near the equipment and shall be easily accessible.
 - 1. Do not ingest battery. Chemical burn hazard!
 - 2. This product contains a coin/button cell battery. If the coin/button cell battery is swallowed, it can cause severe internal burns in just 2 hours and can lead to death.
 - 3. Keep new and used batteries away from children.
 - 4. If the battery compartment does not close securely, stop using the product and keep it away from children.
 - 5. If you think batteries might have been swallowed or placed inside any part of the body, seek immediate medical attention.
 - 6. CAUTION: Risk of explosion if the battery is replaced by an incorrect type.
 - 7. Improper replacement of the battery with an incorrect type may defeat a safeguard (for example, in the case of some lithium battery types).
 - 8. Do not dispose of the battery into fire or a hot oven, or mechanically crush or cut the battery, which may result in an explosion.
 - 9. Do not leave the battery in an extremely high temperature surrounding environment, which may result in an explosion or the leakage of flammable liquid or gas.
 - 10. Do not subject the battery to extremely low air pressure, which may result in an explosion or the leakage of flammable liquid or gas.
 - 11. Dispose of used batteries according to the instructions
- Caution**
 - Do not drop the device or subject it to physical shock, and do not expose it to high electromagnetic radiation. Avoid the equipment installation on vibrations surface or places subject to shock (ignorance can cause equipment damage).
 - Do not place the device in extremely hot (refer to the specification of the device for the detailed operating temperature), cold, dusty or damp locations, and do not expose it to high electromagnetic radiation.
 - Exposing the equipment to direct sun light, low ventilation or heat source such as heater or radiator is forbidden (ignorance can cause fire danger). The device cover for indoor use shall be kept from rain and moisture.
 - Exposing the equipment to direct sun light, low ventilation or heat source such as heater or radiator is forbidden (ignorance can cause fire danger). Please use a soft and dry cloth when clean inside and outside surfaces of the device cover, do not use alkaline detergents.
 - Biometric recognition products are not 100% applicable to anti-spoofing environments. If you require a higher security level, use multiple authentication modes.
 - The serial port of the equipment is used for debugging only.
 - Wall Mounting: Install the equipment according to the instructions in this manual. To prevent injury, this equipment must be securely attached to the floor/wall in accordance with the installation instructions.
 - Improper use or replacement of the battery may result in hazard of explosion. Replace with the same or equivalent type only. Dispose of used batteries according to the instructions provided by the battery manufacturer.
 - This bracket is intended for use only with equipped devices. Use with other equipment may result in instability causing injury.
 - This equipment is for use only with equipped bracket. Use with other (carts, stands, or carriers) may result in instability causing injury.