



Molinete Jaula de Altura Completa

Guia Rapida

Legal Information

© 2020 Hangzhou Hikvision Digital Technology Co., Ltd. All rights reserved.

This Manual is the property of Hangzhou Hikvision Digital Technology Co., Ltd. or its affiliates (hereinafter referred to as "Hikvision"), and it cannot be reproduced, changed, translated, or distributed, partially or wholly, by any means, without the prior written permission of Hikvision. Unless otherwise expressly stated herein, Hikvision does not make any warranties, guarantees or representations, express or implied, regarding to the Manual, any information contained herein.

About this Manual

The Manual includes instructions for using and managing the Product. Pictures, charts, images and all other information hereinafter are for description and explanation only. The information contained in the Manual is subject to change, without notice, due to firmware updates or other reasons. Please find the latest version of this Manual at the Hikvision website (<https://www.hikvision.com/>).

Please use this Manual with the guidance and assistance of professionals trained in supporting the Product.

Trademarks Acknowledgement

- **HIKVISION** and other Hikvision's trademarks and logos are the properties of Hikvision in various jurisdictions.
- Other trademarks and logos mentioned are the properties of their respective owners.

LEGAL DISCLAIMER

TO THE MAXIMUM EXTENT PERMITTED BY APPLICABLE LAW, THIS MANUAL AND THE PRODUCT DESCRIBED, WITH ITS HARDWARE, SOFTWARE AND FIRMWARE, ARE PROVIDED "AS IS" AND "WITH ALL FAULTS AND ERRORS". HIKVISION MAKES NO WARRANTIES, EXPRESS OR IMPLIED, INCLUDING WITHOUT LIMITATION, MERCHANTABILITY, SATISFACTORY QUALITY, OR FITNESS FOR A PARTICULAR PURPOSE. THE USE OF THE PRODUCT BY YOU IS AT YOUR OWN RISK. IN NO EVENT WILL HIKVISION BE LIABLE TO YOU FOR ANY SPECIAL, CONSEQUENTIAL, INCIDENTAL, OR INDIRECT DAMAGES, INCLUDING, AMONG OTHERS, DAMAGES FOR LOSS OF BUSINESS PROFITS, BUSINESS INTERRUPTION, OR LOSS OF DATA, CORRUPTION OF SYSTEMS, OR LOSS OF DOCUMENTATION, WHETHER BASED ON BREACH OF CONTRACT, TORT (INCLUDING NEGLIGENCE), PRODUCT LIABILITY, OR OTHERWISE, IN CONNECTION WITH THE USE OF THE PRODUCT, EVEN IF HIKVISION HAS BEEN ADVISED OF THE POSSIBILITY OF SUCH DAMAGES OR LOSS.

YOU ACKNOWLEDGE THAT THE NATURE OF INTERNET PROVIDES FOR INHERENT SECURITY RISKS, AND HIKVISION SHALL NOT TAKE ANY RESPONSIBILITIES FOR ABNORMAL OPERATION, PRIVACY LEAKAGE OR OTHER DAMAGES RESULTING FROM CYBER-ATTACK, HACKER ATTACK, VIRUS INSPECTION, OR OTHER INTERNET SECURITY RISKS; HOWEVER, HIKVISION WILL PROVIDE TIMELY TECHNICAL SUPPORT IF REQUIRED.

YOU AGREE TO USE THIS PRODUCT IN COMPLIANCE WITH ALL APPLICABLE LAWS, AND YOU ARE SOLELY RESPONSIBLE FOR ENSURING THAT YOUR USE CONFORMS TO THE APPLICABLE LAW. ESPECIALLY, YOU ARE RESPONSIBLE, FOR USING THIS PRODUCT IN A MANNER THAT DOES NOT INFRINGE ON THE RIGHTS OF THIRD PARTIES, INCLUDING WITHOUT LIMITATION, RIGHTS OF PUBLICITY, INTELLECTUAL PROPERTY RIGHTS, OR DATA PROTECTION AND OTHER PRIVACY RIGHTS. YOU SHALL NOT USE THIS PRODUCT FOR ANY PROHIBITED END-USES, INCLUDING THE DEVELOPMENT OR PRODUCTION OF WEAPONS OF MASS DESTRUCTION, THE DEVELOPMENT OR PRODUCTION OF CHEMICAL OR BIOLOGICAL WEAPONS, ANY ACTIVITIES IN THE CONTEXT RELATED TO ANY NUCLEAR EXPLOSIVE OR UNSAFE NUCLEAR FUEL-CYCLE, OR IN SUPPORT OF HUMAN RIGHTS ABUSES.

IN THE EVENT OF ANY CONFLICTS BETWEEN THIS MANUAL AND THE APPLICABLE LAW, THE LATER PREVAILS.

© 2020 Hangzhou Hikvision Digital Technology Co., Ltd. All rights reserved.

This Manual is the property of Hangzhou Hikvision Digital Technology Co., Ltd. or its affiliates (hereinafter referred to as "Hikvision"), and it cannot be reproduced, changed, translated, or distributed, partially or wholly, by any means, without the prior written permission of Hikvision. Unless otherwise expressly stated herein, Hikvision does not make any warranties, guarantees or representations, express or implied, regarding to the Manual, any information contained herein.

About this Manual

The Manual includes instructions for using and managing the Product. Pictures, charts, images and all other information hereinafter are for description and explanation only. The information contained in the Manual is subject to change, without notice, due to firmware updates or other reasons. Please find the latest version of this Manual at the Hikvision website (<https://www.hikvision.com/>).

Please use this Manual with the guidance and assistance of professionals trained in supporting the Product.

Trademarks Acknowledgement

- **HIKVISION** and other Hikvision's trademarks and logos are the properties of Hikvision in various jurisdictions.
- Other trademarks and logos mentioned are the properties of their respective owners.
- **HDMI**™ The terms HDMI and HDMI High-Definition Multimedia Interface, and the HDMI Logo are trademarks or registered trademarks of HDMI Licensing Administrator, Inc. in the United States and other countries.

LEGAL DISCLAIMER

TO THE MAXIMUM EXTENT PERMITTED BY APPLICABLE LAW, THIS MANUAL AND THE PRODUCT DESCRIBED, WITH ITS HARDWARE, SOFTWARE AND FIRMWARE, ARE PROVIDED "AS IS" AND "WITH ALL FAULTS AND ERRORS". HIKVISION MAKES NO WARRANTIES, EXPRESS OR IMPLIED, INCLUDING WITHOUT LIMITATION, MERCHANTABILITY, SATISFACTORY QUALITY, OR FITNESS FOR A PARTICULAR PURPOSE. THE USE OF THE PRODUCT BY YOU IS AT YOUR OWN RISK. IN NO EVENT WILL HIKVISION BE LIABLE TO YOU FOR ANY SPECIAL, CONSEQUENTIAL, INCIDENTAL, OR INDIRECT DAMAGES, INCLUDING, AMONG OTHERS, DAMAGES FOR LOSS OF BUSINESS PROFITS, BUSINESS INTERRUPTION, OR LOSS OF DATA, CORRUPTION OF SYSTEMS, OR LOSS OF DOCUMENTATION, WHETHER BASED ON BREACH OF CONTRACT, TORT (INCLUDING NEGLIGENCE), PRODUCT LIABILITY, OR OTHERWISE, IN CONNECTION WITH THE USE OF THE PRODUCT, EVEN IF HIKVISION HAS BEEN ADVISED OF THE POSSIBILITY OF SUCH DAMAGES OR LOSS.

YOU ACKNOWLEDGE THAT THE NATURE OF INTERNET PROVIDES FOR INHERENT SECURITY RISKS, AND HIKVISION SHALL NOT TAKE ANY RESPONSIBILITIES FOR ABNORMAL OPERATION, PRIVACY LEAKAGE OR OTHER DAMAGES RESULTING FROM CYBER-ATTACK, HACKER ATTACK, VIRUS INSPECTION, OR OTHER INTERNET SECURITY RISKS; HOWEVER, HIKVISION WILL PROVIDE TIMELY TECHNICAL SUPPORT IF REQUIRED.

YOU AGREE TO USE THIS PRODUCT IN COMPLIANCE WITH ALL APPLICABLE LAWS, AND YOU ARE SOLELY RESPONSIBLE FOR ENSURING THAT YOUR USE CONFORMS TO THE APPLICABLE LAW. ESPECIALLY, YOU ARE RESPONSIBLE, FOR USING THIS PRODUCT IN A MANNER THAT DOES NOT INFRINGE ON THE RIGHTS OF THIRD PARTIES, INCLUDING WITHOUT LIMITATION, RIGHTS OF PUBLICITY, INTELLECTUAL PROPERTY RIGHTS, OR DATA PROTECTION AND OTHER PRIVACY RIGHTS. YOU SHALL NOT USE THIS PRODUCT FOR ANY PROHIBITED END-USES, INCLUDING THE DEVELOPMENT OR PRODUCTION OF WEAPONS OF MASS DESTRUCTION, THE DEVELOPMENT OR PRODUCTION OF CHEMICAL OR BIOLOGICAL WEAPONS, ANY ACTIVITIES IN THE CONTEXT RELATED TO ANY NUCLEAR EXPLOSIVE OR UNSAFE NUCLEAR FUEL-CYCLE, OR IN SUPPORT OF HUMAN RIGHTS ABUSES.

IN THE EVENT OF ANY CONFLICTS BETWEEN THIS MANUAL AND THE APPLICABLE LAW, THE LATER PREVAILS.

© 2020 Hangzhou Hikvision Digital Technology Co., Ltd. All rights reserved.

This Manual is the property of Hangzhou Hikvision Digital Technology Co., Ltd. or its affiliates (hereinafter referred to as "Hikvision"), and it cannot be reproduced, changed, translated, or distributed, partially or wholly, by any means, without the prior written permission of Hikvision. Unless otherwise expressly stated herein, Hikvision does not make any warranties, guarantees or representations, express or implied, regarding to the Manual, any information contained herein.

About this Manual

The Manual includes instructions for using and managing the Product. Pictures, charts, images and all other information hereinafter are for description and explanation only. The information contained in the Manual is subject to change, without notice, due to firmware updates or other reasons. Please find the latest version of this Manual at the Hikvision website (<https://www.hikvision.com/>).

Please use this Manual with the guidance and assistance of professionals trained in supporting the Product.

Trademarks Acknowledgement

- **HIKVISION** and other Hikvision's trademarks and logos are the properties of Hikvision in various jurisdictions.
- Other trademarks and logos mentioned are the properties of their respective owners.

LEGAL DISCLAIMER

TO THE MAXIMUM EXTENT PERMITTED BY APPLICABLE LAW, THIS MANUAL AND THE PRODUCT DESCRIBED, WITH ITS HARDWARE, SOFTWARE AND FIRMWARE, ARE PROVIDED "AS IS" AND "WITH ALL FAULTS AND ERRORS". HIKVISION MAKES NO WARRANTIES, EXPRESS OR IMPLIED, INCLUDING WITHOUT LIMITATION, MERCHANTABILITY, SATISFACTORY QUALITY, OR FITNESS FOR A PARTICULAR PURPOSE. THE USE OF THE PRODUCT BY YOU IS AT YOUR OWN RISK. IN NO EVENT WILL HIKVISION BE LIABLE TO YOU FOR ANY SPECIAL, CONSEQUENTIAL, INCIDENTAL, OR INDIRECT DAMAGES, INCLUDING, AMONG OTHERS, DAMAGES FOR LOSS OF BUSINESS PROFITS, BUSINESS INTERRUPTION, OR LOSS OF DATA, CORRUPTION OF SYSTEMS, OR LOSS OF DOCUMENTATION, WHETHER BASED ON BREACH OF CONTRACT, TORT (INCLUDING NEGLIGENCE), PRODUCT LIABILITY, OR OTHERWISE, IN CONNECTION WITH THE USE OF THE PRODUCT, EVEN IF HIKVISION HAS BEEN ADVISED OF THE POSSIBILITY OF SUCH DAMAGES OR LOSS.

YOU ACKNOWLEDGE THAT THE NATURE OF INTERNET PROVIDES FOR INHERENT SECURITY RISKS, AND HIKVISION SHALL NOT TAKE ANY RESPONSIBILITIES FOR ABNORMAL OPERATION, PRIVACY LEAKAGE OR OTHER DAMAGES RESULTING FROM CYBER-ATTACK, HACKER ATTACK, VIRUS INSPECTION, OR OTHER INTERNET SECURITY RISKS; HOWEVER, HIKVISION WILL PROVIDE TIMELY TECHNICAL SUPPORT IF REQUIRED.

YOU AGREE TO USE THIS PRODUCT IN COMPLIANCE WITH ALL APPLICABLE LAWS, AND YOU ARE SOLELY RESPONSIBLE FOR ENSURING THAT YOUR USE CONFORMS TO THE APPLICABLE LAW. ESPECIALLY, YOU ARE RESPONSIBLE, FOR USING THIS PRODUCT IN A MANNER THAT DOES NOT INFRINGE ON THE RIGHTS OF THIRD PARTIES, INCLUDING WITHOUT LIMITATION, RIGHTS OF PUBLICITY, INTELLECTUAL PROPERTY RIGHTS, OR DATA PROTECTION AND OTHER PRIVACY RIGHTS. YOU SHALL NOT USE THIS PRODUCT FOR ANY PROHIBITED END-USES, INCLUDING THE DEVELOPMENT OR PRODUCTION OF WEAPONS OF MASS DESTRUCTION, THE DEVELOPMENT OR PRODUCTION OF CHEMICAL OR BIOLOGICAL WEAPONS, ANY ACTIVITIES IN THE CONTEXT RELATED TO ANY NUCLEAR EXPLOSIVE OR UNSAFE NUCLEAR FUEL-CYCLE, OR IN SUPPORT OF HUMAN RIGHTS ABUSES.

IN THE EVENT OF ANY CONFLICTS BETWEEN THIS MANUAL AND THE APPLICABLE LAW, THE LATER PREVAILS.

Data Protection

During the use of device, personal data will be collected, stored and processed. To protect data, the development of Hikvision devices incorporates privacy by design principles. For example, for device with facial recognition features, biometrics data is stored in your device with encryption method; for fingerprint device, only fingerprint template will be saved, which is impossible to reconstruct a fingerprint image.

As data controller, you are advised to collect, store, process and transfer data in accordance with the applicable data protection laws and regulations, including without limitation, conducting security controls to safeguard personal data, such as, implementing reasonable administrative and physical security controls, conduct periodic reviews and assessments of the effectiveness of your security controls.

© 2020 Hangzhou Hikvision Digital Technology Co., Ltd. All rights reserved.

This Manual is the property of Hangzhou Hikvision Digital Technology Co., Ltd. or its affiliates (hereinafter referred to as "Hikvision"), and it cannot be reproduced, changed, translated, or distributed, partially or wholly, by any means, without the prior written permission of Hikvision. Unless otherwise expressly stated herein, Hikvision does not make any warranties, guarantees or representations, express or implied, regarding to the Manual, any information contained herein.

About this Manual

The Manual includes instructions for using and managing the Product. Pictures, charts, images and all other information hereinafter are for description and explanation only. The information contained in the Manual is subject to change, without notice, due to firmware updates or other reasons. Please find the latest version of this Manual at the Hikvision website (<https://www.hikvision.com/>).

Please use this Manual with the guidance and assistance of professionals trained in supporting the Product.

Trademarks Acknowledgement

- **HIKVISION** and other Hikvision's trademarks and logos are the properties of Hikvision in various jurisdictions.
- Other trademarks and logos mentioned are the properties of their respective owners.
- **HDMI**™ The terms HDMI and HDMI High-Definition Multimedia Interface, and the HDMI Logo are trademarks or registered trademarks of HDMI Licensing Administrator, Inc. in the United States and other countries.

LEGAL DISCLAIMER

TO THE MAXIMUM EXTENT PERMITTED BY APPLICABLE LAW, THIS MANUAL AND THE PRODUCT DESCRIBED, WITH ITS HARDWARE, SOFTWARE AND FIRMWARE, ARE PROVIDED "AS IS" AND "WITH ALL FAULTS AND ERRORS". HIKVISION MAKES NO WARRANTIES, EXPRESS OR IMPLIED, INCLUDING WITHOUT LIMITATION, MERCHANTABILITY, SATISFACTORY QUALITY, OR FITNESS FOR A PARTICULAR PURPOSE. THE USE OF THE PRODUCT BY YOU IS AT YOUR OWN RISK. IN NO EVENT WILL HIKVISION BE LIABLE TO YOU FOR ANY SPECIAL, CONSEQUENTIAL, INCIDENTAL, OR INDIRECT DAMAGES, INCLUDING, AMONG OTHERS, DAMAGES FOR LOSS OF BUSINESS PROFITS, BUSINESS INTERRUPTION, OR LOSS OF DATA, CORRUPTION OF SYSTEMS, OR LOSS OF DOCUMENTATION, WHETHER BASED ON BREACH OF CONTRACT, TORT (INCLUDING NEGLIGENCE), PRODUCT LIABILITY, OR OTHERWISE, IN CONNECTION WITH THE USE OF THE PRODUCT, EVEN IF HIKVISION HAS BEEN ADVISED OF THE POSSIBILITY OF SUCH DAMAGES OR LOSS.

YOU ACKNOWLEDGE THAT THE NATURE OF INTERNET PROVIDES FOR INHERENT SECURITY RISKS, AND HIKVISION SHALL NOT TAKE ANY RESPONSIBILITIES FOR ABNORMAL OPERATION, PRIVACY LEAKAGE OR OTHER DAMAGES RESULTING FROM CYBER-ATTACK, HACKER ATTACK, VIRUS INSPECTION, OR OTHER INTERNET SECURITY RISKS; HOWEVER, HIKVISION WILL PROVIDE TIMELY TECHNICAL SUPPORT IF REQUIRED.

YOU AGREE TO USE THIS PRODUCT IN COMPLIANCE WITH ALL APPLICABLE LAWS, AND YOU ARE SOLELY RESPONSIBLE FOR ENSURING THAT YOUR USE CONFORMS TO THE APPLICABLE LAW. ESPECIALLY, YOU ARE RESPONSIBLE, FOR USING THIS PRODUCT IN A MANNER THAT DOES NOT INFRINGE ON THE RIGHTS OF THIRD PARTIES, INCLUDING WITHOUT LIMITATION, RIGHTS OF PUBLICITY, INTELLECTUAL PROPERTY RIGHTS, OR DATA PROTECTION AND OTHER PRIVACY RIGHTS. YOU SHALL NOT USE THIS PRODUCT FOR ANY PROHIBITED END-USES, INCLUDING THE DEVELOPMENT OR PRODUCTION OF WEAPONS OF MASS DESTRUCTION, THE DEVELOPMENT OR PRODUCTION OF CHEMICAL OR BIOLOGICAL WEAPONS, ANY ACTIVITIES IN THE CONTEXT RELATED TO ANY NUCLEAR EXPLOSIVE OR UNSAFE NUCLEAR FUEL-CYCLE, OR IN SUPPORT OF HUMAN RIGHTS ABUSES.

IN THE EVENT OF ANY CONFLICTS BETWEEN THIS MANUAL AND THE APPLICABLE LAW, THE LATER PREVAILS.

Data Protection

During the use of device, personal data will be collected, stored and processed. To protect data, the development of Hikvision devices incorporates privacy by design principles. For example, for device with facial recognition features, biometrics data is stored in your device with encryption method; for fingerprint device, only fingerprint template will be saved, which is impossible to reconstruct a fingerprint image.

As data controller, you are advised to collect, store, process and transfer data in accordance with the applicable data protection laws and regulations, including without limitation, conducting security controls to safeguard personal data, such as, implementing reasonable administrative and physical security controls, conduct periodic reviews and assessments of the effectiveness of your security controls.

Regulatory Information

FCC Information

Please take attention that changes or modification not expressly approved by the party responsible for compliance could void the user's authority to operate the equipment.

FCC compliance: This equipment has been tested and found to comply with the limits for a Class A digital device, pursuant to part 15 of the FCC Rules. These limits are designed to provide reasonable protection against harmful interference when the equipment is operated in a commercial environment. This equipment generates, uses, and can radiate radio frequency energy and, if not installed and used in accordance with the instruction manual, may cause harmful interference to radio communications. Operation of this equipment in a residential area is likely to cause harmful interference in which case the user will be required to correct the interference at his own expense.

FCC Conditions

This device complies with part 15 of the FCC Rules. Operation is subject to the following two conditions:

1. This device may not cause harmful interference.
2. This device must accept any interference received, including interference that may cause undesired operation.

EU Conformity Statement

 This product and - if applicable - the supplied accessories too are marked with "CE" and comply therefore with the applicable harmonized European standards listed under the EMC Directive 2014/30/EU, the LVD Directive 2014/35/EU, the RoHS Directive 2011/65/EU.

 2012/19/EU (WEEE directive): Products marked with this symbol cannot be disposed of as unsorted municipal waste in the European Union. For proper recycling, return this product to your local supplier upon the purchase of equivalent new equipment, or dispose of it at designated collection points. For more information see: www.recyclethis.info

 2006/66/EC (battery directive): This product contains a battery that cannot be disposed of as unsorted municipal waste in the European Union. See the product documentation for specific battery information. The battery is marked with this symbol, which may include lettering to indicate cadmium (Cd), lead (Pb), or mercury (Hg). For proper recycling, return the battery to your supplier or to a designated collection point. For more information see: www.recyclethis.info

Industry Canada ICES-003 Compliance

This device meets the CAN ICES-3 (A)/NMB-3(A) standards requirements.



Applicable Models

This manual is applicable to the models listed in the following table.

Series	Model
DS-K3H44XX	DS-K3H4420-120
	DS-K3H4410-120
	DS-K3H4421-120
	DS-K3H4411-120

Symbol Conventions

The symbols that may be found in this document are defined as follows.

Symbol	Description
 Note	Provides additional information to emphasize or supplement important points of the main text.
 Caution	Indicates a potentially hazardous situation, which if not avoided, could result in equipment damage, data loss, performance degradation, or unexpected results.
 Danger	Indicates a hazard with a high level of risk, which if not avoided, will result in death or serious injury.

Safety Instructions

- Proper configuration of all passwords and other security settings is the responsibility of the installer and/or end-user.
- In the use of the product, you must be in strict compliance with the electrical safety regulations of the nation and region. Please refer to technical specifications for detailed information.
- Input voltage should meet both the SELV (Safety Extra Low Voltage) and the Limited Power Source with 100 to 240 VAC or 12 VDC according to the IEC60950-1 standard. Please refer to technical specifications for detailed information.
- Do not connect several devices to one power adapter as adapter overload may cause over-heating or a fire hazard.
- Please make sure that the plug is firmly connected to the power socket.
- If smoke, odor or noise rise from the device, turn off the power at once and unplug the power cable, and then please contact the service center.

CONTENTS

Chapter 1 Product introduction.....	5
1.1 Brief introduction.....	5
1.2 Product structure and principle.....	5
1.3 Function Features.....	7
1.4 Technical parameter.....	7
Chapter 2 Equipment Installations.....	8
2.1 Installation notes.....	8
2.2 Equipment Installation.....	8
2.3 Connection.....	10
2.4 Debugging instruction.....	10
2.5 Notice of use.....	11
Chapter 3 Board and parameter instruction.....	12
3.1 Board instruction.....	12
3.2 Wiring diagram.....	13
3.3 DIP switch instructions.....	13
Chapter 4 Trouble shooting and maintenance.....	15
4.1 Trouble shooting.....	15
4.2 Maintenance.....	16

Chapter 1 Product introduction

1.1 Breve introducción

El torniquete completamente alto es un tipo de equipo de control de acceso diseñado para lugares con requisitos de seguridad de clase alta.

Las series altas completas son completamente aplicables a lugares con mucho tráfico como una escuela, fábrica, parques, la viviendas fincas y otros lugares.

1.2 Estructura y principio del producto.

La estructura del producto está compuesta principalmente por un sistema mecánico y un sistema de control eléctrico.

El sistema mecánico está compuesto por caja superior ,columna lateral ,barandilla ,eje de rotación ,apoyo pedestal ,núcleo.

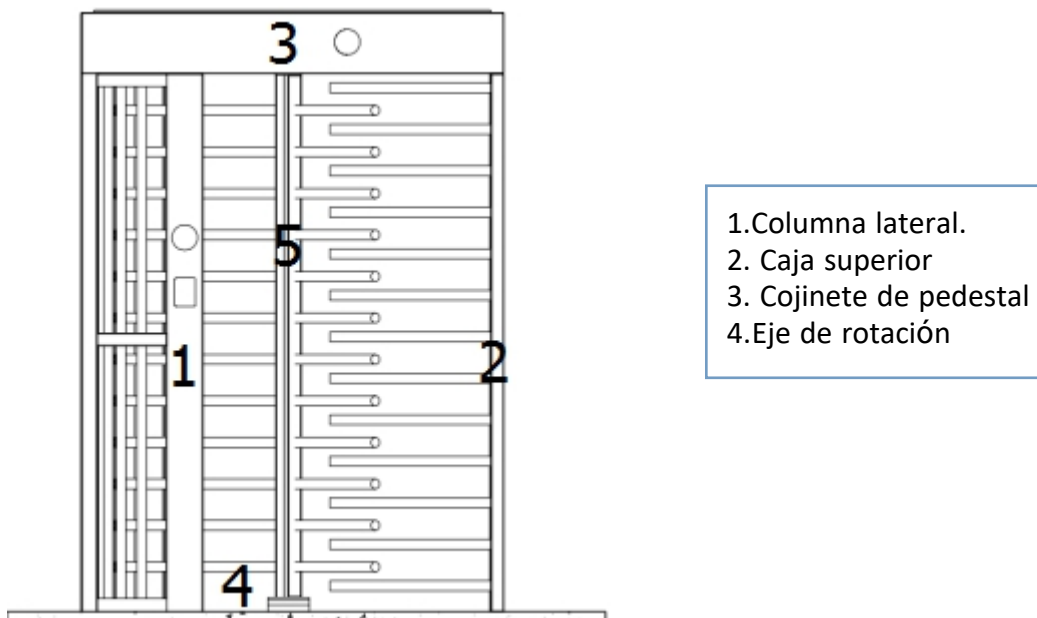

Molinete 120° grados

El sistema de control eléctrico consiste en un dispositivo de control de acceso (pedido por separado), tablero de control,

indicador de dirección, sensor de posición, solenoide, amortiguador, fuente de alimentación.

NO	Name	Function
1	Dispositivo control de acceso	Control de acceso de tarjeta IC/ID, huellas dactilares, reconocimiento facial, lector de códigos, dispositivos de control de acceso que envían una señal de relé a la señal de la puerta del tablero del molinete.
2	Tabla de control	El centro de control del sistema, cuando recibe la señal del dispositivo de control de acceso, controla el solenoide abierto, la luz indicadora de dirección se vuelve verde, la varilla de rotación se puede empujar a 90 grados o 120 grados, el solenoide se bloqueará inmediatamente cuando reciba la señal de cierre desde la posición central sensor
3	Indicador	Mostrar el estado actual del canal
4	Sensor posicion	Detecta y controla la posición de apertura y cierre de la puerta
5	solenoid	Eje de bloqueo
7	Damper	hace que el eje funcione sin problemas
8	Power Supply	suministro de energía al tablero de control

Sistema Operación Principio

1) Encienda la alimentación,

2 segundos más tarde; el sistema entra en modo de trabajo; la varilla no puede girar..

3) El tablero de control recibe una señal abierta, el indicador de control se vuelve verde, el solenoide se abre, la varilla de rotación se puede empujar a 90 grados o 120 grados.

4) Después de que la varilla de empuje del pasajero y luego la rotación gire a 90 o 120 grados, el sensor de posición envía la señal de cierre al tablero de control, el solenoide se bloquea inmediatamente

5) Los torniquetes completos se bloquearán después de 5 segundos si los pasajeros limpian la tarjeta pero no pasan.

1.3 Function Features

- Damper buffer device
- Standard signal input port, can be connected with most of the access control board, fingerprint device and scanner other equipment;
- The turnstile has automatic reset function, if people swipe the authorized card, but don't pass through within the settled time, it need to swipe card again for entry;
- Card-reading Recording function
- Automatic opening after emergency fire signal input
- Anti following : prevent illegal passing
- High light LED indicator , displaying passing status
- Normal open can be also controlled via external button or manual key unlock
- Gate will automatically open when power failure

1.4 Technical parameter

Basic Parameters		
1	Input voltage	AC 220V 50HZ
2	Work voltage	DC 24V /50W
3	Housing Material	304 Stainless Steel
4	Arm rotation angle	90/120 degree
5	Lane Width	≤650mm
6	Opening response time	≤0.2s
7	Open Signal	Passive signals (relay signals, dry contact signals,)
8	Communication	RS485
9	Pass rate	25-30 person/min

10	Fire /Emergency Alarm/	Gate open, free for passing
11	Working Temperature	-20°C~+70°C
12	Working environment	Indoor and outdoor

Chapter 2 Equipment Installations

2.1 Installation notes

- Please read this manual carefully before install it;
- As for the convenience of installation and maintenance, installation space height of at least 2.6 meters;
- Make sure the whole is horizontal and the shaft is vertical;
- Protective earth wire must be connected;
- Please check all wires has been properly connected before power on;
- Please test all function before using;

2.2 Equipment Installation

1) Tool preparations

1	A set of hexagon spanner	5	Screw driver and other common wiring tool
2	Cross screwdriver 6mm	6	Millimeter
3	Open spanner 17-19mm	7	M12x100 Expansion screws 8pcs
4	Impact drill(including D16 and D14 drills)	8	Cable Tester

2) Ensure the installation location and the system composition ,prepare to install after carrying out the system planning;

3) Make well of installation of equipment foundation base.

4) Assemble the machine, refer to the picture.

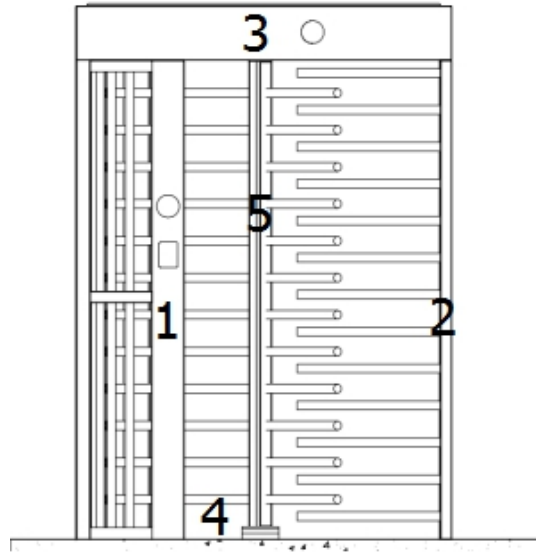

Assemble both sides of guardrail 1 part and 2 part firstly. Then place the 3 part top upper box over the 1 part and 2 part and tighten the mounting screws; lay 4 part bearing mechanism at the bottom of a rotating shaft; install 5 part rotation, tighten the top mounting screws; check the verticality of the shaft. Adjust and check the level and vertical of the machine.

5) Mark the fixing position of expansion bolts according to fixing plate on the bottom of each turnstile.

6) Drill hole by impact drill, fix Expansion screws.

7) Tighten the expansion screw after the functional test is completed

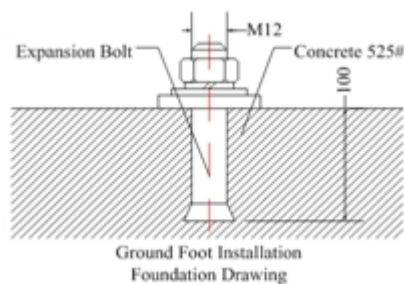

8) The card reader is installed on the column.

2.3 Connection

1) Connect wire of indicator

Indicator port is placed above the guardrail and inserted into the VCC D1 D2 GND port of the control board.

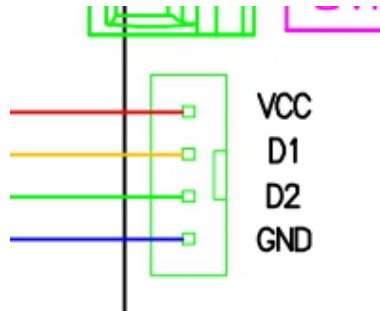

2) Connect wire of access control device



3) Connecting AC220V power input

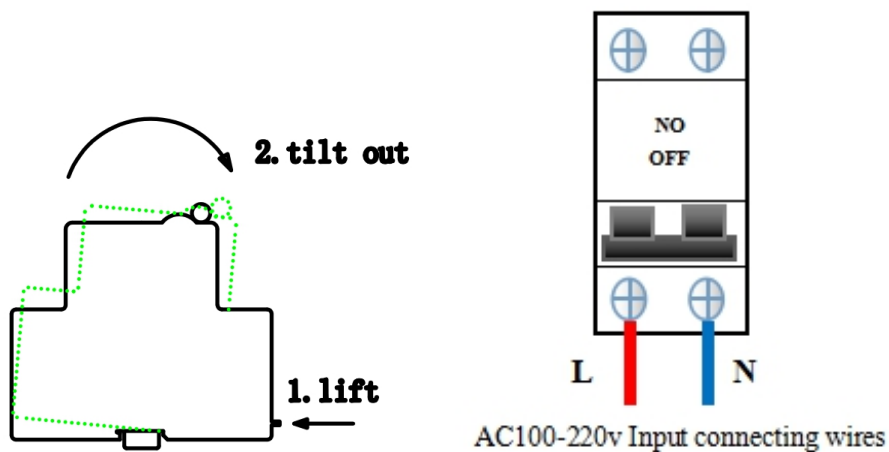

2.4 Debugging instruction

1) Check wire: Check whether the connection wire of the gate and the power line are properly

connected before power on.

2) Function test:

- Access control relay time should be set to 0 seconds or 1 second;
- Rod can not push without swipe valid card
- Indicator will show green and the rod of rotation can be pushed to 90 degree or 120 degree when swipe valid card.
- If passager not go through ,turnstile will lock after 5 seconds

2.5 Notice of use

- If it tests well before installation, then fixed it; before you install and maintain it, please cut off the power;
- The product must be earthed, and an earth leakage breaker is necessary on the power supply;
- Follow the order and pass one by one
- Please keep the control button or remote control far away from the children;
- Please don't use the turnstile under the thunder and lightning condition to get rid of damage to the equipment.

Chapter 3 Board and parameter instruction

3.1 Board instruction

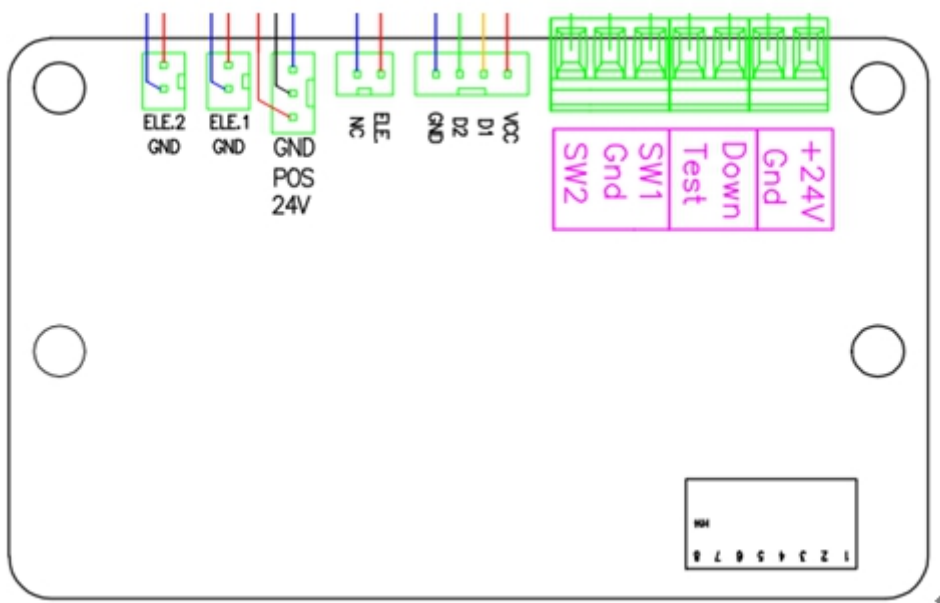

No	Port Sign	Instructions
1	+24V	24V input power supply to PCB board
	GND	
2	Down Test	Drop rod interface
3	SW1 GND	Entry opening signal input, Dry contact signal and Access control PCB board entry opening relay signal (NO connect SW1, COM connect GND, and the relay time of access control board should be set "0" or "1")
4	SW2 GND	Exit opening signal input, Dry contact signal and Access control PCB board exit opening relay signal (NO connect SW2, COM connect GND, and the relay time of access control board should be set "0" or "1")
6	VCC D1 D2 GND	VCC、GND: +12 V power supply for indicator D1: Entry LED indicator signal input D2: Exit LED indicator signal input
7	ELE.NC	12V circular electromagnet port

8	GND POS 24V	Position sensor full close in place signal input,once arm turn 120 degree , it will give closing gate signal
10	ELE.1 GND	Output for entry square solenoid, normally 0v t, when board recieve open singal,This port will be 24v output
11	ELE.2 GND	Output for exit square solenoid, normally 0v t, when board recieve open singal,This port will be 24v output

3.2 Wiring diagram

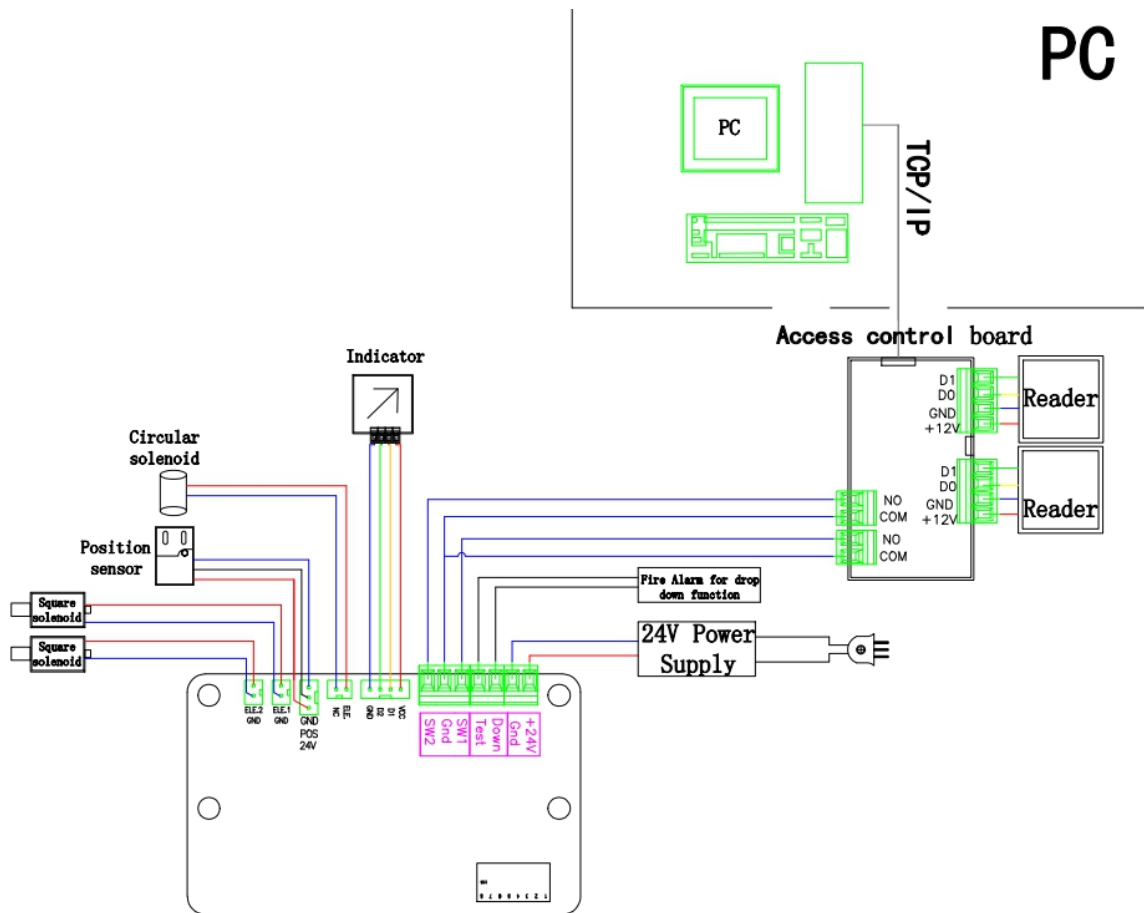

3.3 DIP switch instructions

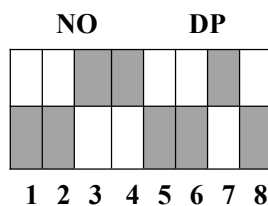

Dial 1-3: traffic duration;
 Dial 4-8: function mode setting;

Function mode setting					Dial code			Automatic reset
8	7	6	5	4	3	2	1	Times
4. Restore factory settings: dial code 4 to on before power on, and dial code 4 to off after power on.					0	0	0	5S
					0	0	1	6S
					0	1	0	7S
5. Water light - light bar mode: (the default dial off is water light)Set the light bar mode: dial code 4 and 5 to on before power on, and dial code 4 to off after power on.					0	1	1	8S
					1	0	0	9S
					1	0	1	10S
6. Electromagnet working mode: (the default dial on is normal power supply, switch on and power off)Set the normal power-off and switch on power supply: dial code 6 to off before power on, and then power on again.					1	1	0	11S
					1	1	1	12S
7. Working mode of induction switch: (default dial on limit switch)Set the travel switch: turn code 7 to off before power on, and then power on again.								
8. Traffic memory: (the default dial off is not enabled)Set the access memory: dial code 8 to on before power on, and then power on again.								

with memory function, if swiping valid card 5 times, it can pass five peoples; without memory function, if swiping valid card 5 times, it only can pass one people.

Chapter 4 Trouble shooting and maintenance

4.1 Trouble shooting

Q1: When access board send open signal, arm move reverse and indicator show reverse?

Reasons: open signal reverse connection

Solution: exchange SW1 GND and SW2 GND terminal of board.

Q2: Indicator is not working?

Reasons: 1. wires loose 2. indicator or board damage

Solution:

1. Check connect wire of indicator
2. Replace indicator or board.

Q3: How to achieve free for one way ?

1. Remove one of square solenoid

Q4: Arm can not push when swipe card and indicator show green ?

Solution: 1. Check 24V GND output for square solenoid 2. Replace new board or solenoid

Q5: Passing two or three people after swipe card at a time.

Reasons:

1. The Position sensor didn't be touched by the right screw cap when the turn plate rotating. (Or didn't receive the effective signal even touched)
2. The square solenoid does not stretch smoothly.
3. Control board damage

Solution:

1. Move the position sensor inward, Check connect wires to board
2. Adjust square solenoid or replace new one.

3. Changing the square solenoid.

4. Replace a new board.

Q6: Rod can't turn 90 degrees or 120 degree for one pass?

Reasons:

1. The position sensor is too close to the wheel;
2. If the speed go through is too slow and times out.

Solution:

1. Open the cover of to box , adjust position senso
2. Set DIP switch

Q7: It is hard to push the shaft rotation?

Reasons: 1. Bottom bearing rust or damage; 2. The shaft is not vertical

Solution: 1. Replace new bearing 2. Adjust the shaft to vertical

4.2 Maintenance

Full high turnstile require regular maintenance by professionals and daily cleaning to ensure long-term stability and extended equipment life.

1. Maintenance Content:

- Keep the turnstile housing and card reader panels of turnstile gates clean;
- Fasten and lubricate the internal movement structure;
- Check the dust of the driver board and make it cleans.
- Check the connectors and wiring points to ensure the reliability of the connection.
- Check the bearings at the bottom of the shaft

2 Maintenance Methods:

1. Cleaning: Check the housing and card reader panels of the gate, and remove the dust and other dirt to make them clean;wipe rust inhibitor to keep stainless steel bright
2. Rust removal and Lubrication: Check the movement of the flap /slide gate and swing gate, remove

rust with sand paper and spread with anti-rust oil if corroded;

3. Screws fastening: Check the connection of the various moving parts, fasten the screws where they are loose to avoid causing fault for long-running;

4. Cleaning the bearings at the bottom of the shaft and add grease.

5. Circuit board cleaning: Cut off the power, and wipe dust of the board by using a clean brush;

6. Lines Checking: Check the connecting lines and solder reinforcement if they are loose off.

Note: This product is the strong professional technical equipment. In addition to daily maintenance, please do not feel free to disassemble it. If a fault occurs while running, Please notify our service departments or the authorized service agencies promptly to have it maintained. Do not disassemble it at random to avoid damaging the internal structure or even damaging your interests because of your improper operation.



✉ ventas@rosarioseguridad.com.ar

☎ +54 9 341 6708000

☎ +54 9 341 6799822

📷 [rosarioseguridadok](https://www.instagram.com/rosarioseguridadok)

📺 Rosario Seguridad

📘 Rosario Seguridad

Grupo Instaladores

📘 <https://www.facebook.com/groups/591852618012744/>

☎ +54 9 341 6591429

☎ +54 9 341 4577532

Avenida Presidente Perón 3998 - Rosario - Santa Fe - Argentina